

# Operating manual

## Condor Basis pump control CPSB

Status: 27.01.2010

Version: 900 200 – V1.2

GLP: HW 1.10

SW: V3.09



**This documentation refers exclusively to the control unit and contains basic information that must be adhered to during installation, operation and maintenance. The fitter who installs the equipment, as well as any technical staff/operators must read this manual before installation and operation. The manual must also always be available at the equipment's place of installation.**

The control unit is available with different equipment options. This operating manual specifically describes the control functions. Depending on the configuration of the control unit, some of the functions described in this operating manual may not be available. In particular, the one-pump version of the control unit does not have all the functions and features of the two-pump control unit.

The personnel in charge of operation, maintenance, inspection and installation must have the qualifications required for these activities. Areas of responsibility, competences and monitoring of personnel must be clearly defined by the operator.

Non-compliance with any of the safety information results in a loss of any right to claim damages.



**Condor Pressure Control GmbH**  
Warendorfer Straße 47-51  
D-59320 Ennigerloh

Phone: +49 (0)2587 89 - 0  
Telefax: +49 (0)2587 89 - 140  
<http://www.condor-cpc.com>  
[info@condor-cpc.com](mailto:info@condor-cpc.com)

# Operating manual

## Basis pump control CPSB



### TABLE OF CONTENTS

	Page
<b>1. General information</b>	<b>3</b>
<b>2. Notes on safety</b>	<b>3</b>
2.1 Identification of information in the operating manual	3
2.2 Workers' qualifications	3
2.3 Dangers of non-compliance with the safety information	3
2.4 Safety-conscious working	4
2.5 Safety information for the operator / operative	4
2.6 Safety information for installation and maintenance work	4
2.7 Unauthorized alterations and spare parts	5
2.8 Improper forms of operation	5
2.9 Use in explosion hazardous areas	5
<b>3 Transportation and interim storage</b>	<b>6</b>
3.1 Transportation	6
3.2 Interim storage	6
<b>4 General description of the control unit</b>	<b>6</b>
<b>5 Installation / assembly</b>	<b>7</b>
5.1 Environmental conditions	7
5.2 Installation instructions	7
5.3 Hole pattern	7
5.4 Retrofitting a dynamic pressure measurement module	8
5.5 Retrofitting Zener barriers	9
5.6 Retrofitting an accumulator	10
<b>6. Electrical Connection</b>	<b>11</b>
6.1 Connection diagram	11
6.2 Terminal assignment	12
6.3 Emergency float 230V	12
6.4 External shutdown / remote shutdown / dry run protection	12
6.5 External alarm	12
6.6 Connection of the level measurement when using a Zener barrier	12
<b>7 Operation and Displays</b>	<b>13</b>
7.1 Overview	13
7.2 Main display control with two-line display	15
7.3 Main display control with graph. display	16
7.4 Pump operating mode	17
7.5 Using a 2-pump control unit as a 1-pump control unit	17
7.6 Messages after system start-up	17
<b>8 Functional description</b>	<b>18</b>
8.1 Level measurement methods	18
8.2 Pump control	20
8.3 Fault messages and alarms	20
8.4 Pump activation sequence	21
<b>9 On site fuse protection</b>	<b>29</b>
9.1 Main switch	29
9.2 Motor circuit breaker	29
9.3 Accumulator	30

9.4	Intrinsically safe circuits	30
9.5	Thermal contacts / coil protection contacts (Klixon or bimetallic)	31
9.6	Thermal contacts as PTC thermistors	31
9.7	Monitoring impermeability/ moisture sensor	31
9.8	Compressor or agitator	31
9.9	Communication	32
<b>10</b>	<b>System menu / parameter settings for a control unit with a two-line display</b>	<b>33</b>
10.1	Overview Main Menu	33
10.2	Sub-menu „Level measurement method“	34
10.3	Sub-menu „Pump data“	36
10.4	Sub-menu „Communication“	38
10.5	Sub-menu „Alarms“	41
10.7	Sub-menu „Timer“	45
10.8	Sub-menu “Compressor or agitator”:	47
<b>11</b>	<b>System menu / parameter settings for a control unit with a graph. display</b>	<b>49</b>
11.1	Overview Main Menu	49
11.2	Sub-menu „Service“ (#032)	50
11.3	Sub-menu „Timer“ (#048)	51
11.4	Sub-menu „Level measurement method“ (#064)	51
11.5	Sub.menu „Pump data“ (#080)	53
11.6	Sub-menu „Communication“ (#096)	55
11.7	Sub-menu „Alarms“ (#112)	58
11.8	Sub-menu „Basic settings“ (#128)	60
11.9	Sub-menu „System data“ (#144)	62
11.10	Sub-menu “Compressor or agitator”( #192)	63
<b>12</b>	<b>Start-up / re-start</b>	<b>65</b>
<b>13.</b>	<b>Removal from service</b>	<b>65</b>
<b>14.</b>	<b>Maintenance</b>	<b>66</b>
<b>15.</b>	<b>Technical data</b>	<b>66</b>
<b>16.</b>	<b>Symbol definition</b>	<b>67</b>
<b>17.</b>	<b>Fault list</b>	<b>68</b>
<b>18.</b>	<b>Error code table (mask codes) for control units with two-line displays</b>	<b>70</b>
<b>19.</b>	<b>Factory settings</b>	<b>71</b>
<b>20.</b>	<b>Examples of alarm settings</b>	<b>72</b>
<b>21.</b>	<b>SMSC-No. - list</b>	<b>73</b>
<b>22.</b>	<b>Declaration of Conformity</b>	<b>76</b>

### 1. General information

This control unit has been designed using the latest technology, manufactured with great care and is subject to continuous quality control.

The aim of this operating manual is to simplify the process of getting to know the device and making use of its possible end-uses in accordance with its intended purpose.

This operating manual contains important information required to operate the device safely, correctly and economically. Adhering to this information is necessary to ensure the reliability and long life of the device as well as to avoid risks.

The operating manual does not take local regulations into account. It is the operator's responsibility to ensure compliance with these regulations, including by installation personnel.

This device must not be operated if the values stipulated in the technical documentation for operating voltage, rated mains frequency, ambient air temperature, switching capacity and other information contained in this operating manual are exceeded.

If additional information or advice is required, as well as in the event of a claim, please contact the manufacturer.

### 2. Notes on safety

This documentation refers exclusively to the control unit and contains basic information that must be adhered to during installation, operation and maintenance. The fitter who installs the equipment, as well as any technical staff/operators must read this manual before installation and operation. The manual must also always be available at the equipment's place of installation.

As well as the general safety information found in this section "Notes on safety", the specific safety information found in the subsequent sections must also be observed.

#### 2.1 **Identification of information in the operating manual**

The safety information contained in this operating manual, which, if not complied with, could result in danger to people, is marked with the following symbols.



**Warning - general hazards**



**Warning - electrical voltage**

#### 2.2 **Workers' qualifications**

The personnel in charge of operation, maintenance, inspection and installation must have the qualifications required for these activities. Areas of responsibility, competences and monitoring of personnel must be clearly defined by the operator. Staff who do not possess the necessary knowledge must be trained and duly instructed. The operator must also ensure that the contents of this operating manual have been fully understood by all personnel involved.

#### 2.3 **Dangers of non-compliance with the safety information**

Non-compliance with the safety information could result in danger to people as well as to the equipment. Non-compliance with any of the safety information results in a loss of any right to claim damages.

Specifically, non-compliance could lead to the following:

- Failure of important functions of the device
- Failure of prescribed monitoring methods
- Electrical danger to personnel



### 2.4 Safety-conscious working

The safety information in this operating manual, existing national regulations on accident prevention as well as the operator's internal work, operation and safety regulations must be observed.



**Switch off all power to the equipment before opening it**

### 2.5 Safety information for the operator / operative

Any possible risks associated with electricity must be eliminated (detailed information can be found in national regulations and the regulations of local energy supply companies). The operator is responsible for ensuring that the control unit is protected against unauthorised access.

### 2.6 Safety information for installation and maintenance work

The operator must ensure that all maintenance, inspection and installation activities are carried out by qualified personnel, equipped with all necessary information through thorough study of this operating manual.

As a basic principle, work on the device should only be carried out when the power has been switched off. Once the work has been completed, all safety and protective equipment must be re-attached or re-started. Before restarting operation of the equipment, the guidelines found in the "Start-up" section must be observed.

Any relevant applicable regulations (EN, VDE, ...) as well as regulations provided by the local energy supplier must be observed. Start-up can only occur when they have been fulfilled.



**When carrying out the following work, it is essential to refer to the appropriate connection and wiring diagrams of the control unit and the documentation for all accessories, such as the pumps.**

Before starting up the unit and switching on the power supply it is necessary to ensure the following:

- The control unit and the connector cables should not show any signs of damage.
- The terminal screws and terminals should be inspected before operation and tightened if necessary.
- The type and laying of all cables and wires must comply with the relevant regulations. Special care must be taken to ensure that the cable feeds are not subjected to high mechanical stresses, such as might occur through insufficiently fixed or strain-relieved cables.
- The mains connection and the connection to all accessories, such as the pump, must be of a professional standard.
- The fuses are installed for the required nominal current.
- All other connections have been carried out correctly to a suitably professional standard.
- The equipment is closed in accordance with the regulations and any unused cable fittings are closed off.
- The equipment is professionally secured.



**Gases from the shaft must not be allowed to enter the control unit. It is therefore necessary to hermetically seal the cable / air hose entry hole leading from the container to the control unit.**

### 2.7 Unauthorized alterations and spare parts

The control unit may only be altered or changed with the manufacturer's agreement. It is only safe to use original spare parts. Use of other parts may remove liability for any resulting consequences.

### 2.8 Improper forms of operation

Operational safety of the control unit is only guaranteed if it is used in accordance with its intended purpose. The limits provided in this documentation should not be exceeded under any circumstances.

### 2.9 Use in explosion hazardous areas

Individual areas within the plant may be potentially explosive.

It must be ensured that the electronic controller is installed outside these explosion hazardous areas.

Any equipment used in explosion hazardous areas must be suitable for their specific use and application.

Any specific regulations or special conditions for the use of equipment in explosion hazardous areas must also be observed.

It is particularly emphasised that it is the operator's responsibility to

- guarantee compliance with the existing regulations.
- carry out installation in accordance with the relevant existing regulations.
- carry out the required inspections and provide corresponding documentation.
- only install appropriate and authorised components (such as pumps, level sensors, ...)



**When using sensors in explosion hazardous areas, they must be wired via an intrinsically safe circuit, for example via a zener barrier. If level sensors are used, they must have ATEX approval. Float switches do not require special approval.**



**Zener barrier(s) should be factory-installed. If retrofitting is necessary, the prescribed procedures must be followed and appropriate dividers may be required to provide the stipulated 5cm safe clearance.**

**Closed or open dynamic pressure measuring system for Zone 2:** The dynamic pressure measuring system can be used in Zone 2 without any problems, since this measuring system is considered safe during normal operation.

**Closed or open dynamic pressure measuring system for Zone 1:** There is no general rule regarding possible applications of this system. It is necessary to distinguish between the different types of dynamic pressure measuring systems:

**Open dynamic pressure measuring system with "measuring bell release" and closed dynamic pressure measuring system for Zone 1:** This is not generally recommended, as common faults (e.g. damage to the pneumatic hose) may allow potentially explosive gases to reach the control unit, resulting in a change in the Zone.



Open dynamic pressure measuring system with "air bubbling system" for Zone 1: This system is frequently used for Zone 1. With this system, two errors need to occur (e.g. air compressor malfunction **and** damage to the pneumatic hose) for potentially explosive gases to reach the control unit, resulting in a change in the Zone. As the air compressor can stop working when the minimum pressure is polled and this is reported as a fault, the possibility of an error remaining unnoticed and a second error also occurring is reduced.

Dynamic pressure measuring system for Zone 0: No dynamic pressure measuring system provides enough protection for Zone 0, since it is not considered safe with 2 unrelated faults.

### 3 Transportation and interim storage

#### 3.1 Transportation

Transportation of the equipment must be carried out to a professional standard. The control unit will have been inspected before dispatch to ensure it complies with the agreed specifications. The control unit should therefore be in a flawless electrical and mechanical state on arrival. Please check the control unit on arrival for possible damage during transportation. To make a claim, a damage assessment should be drawn up with the supplier.

#### 3.2 Interim storage

The equipment must be stored in a dry place that is free from vibrations and, if possible, kept it in the original packaging. The ambient air temperature should be between -20°C and +70°C.

### 4 General description of the control unit

The basic control unit, to which up to two pumps can be connected, has been specially designed for use in the sewage sector. The control unit measures and monitors the level of the medium and, depending on the level, switches one or two pumps on. As well as the level measuring system, the control unit monitors the motor circuit breakers and thermal contacts of the pumps. The control unit also has integrated systems for measuring the current and counting the number of operating hours and operating cycles as well as a flexible alarm messaging system.

These operating instructions describe the control functions in particular. Depending on the configuration of the control unit, some of the functions described in these operating instructions may not be available.

## 5 Installation / assembly

### 5.1 Environmental conditions

- dry and frost-proof
- sufficient ventilation
- the control unit must be installed in a flood-proof area.



**The control unit is not explosion-proof and must therefore be installed outside the explosion hazardous area.**

### 5.2 Installation instructions

The device should be installed on a wall. Open the lid and attach using 4 screws, for example Spax type 4.0 – 4.5 x 35 - 55 mm and four 6 mm rawl plugs. Make the necessary electrical connections after installation.

#### **Warning**

When working on the device, make sure that no moisture can enter the control unit. Whenever the control unit lid is open during installation or when working on the electrical connections, moisture must be prevented from penetrating, even during light rain, for example by covering it with a tarpaulin. After installation and during longer breaks, screw the lid shut.



**To maintain the required level of protection the casing door must be closed tightly. Unused screw holes must be filled with a dummy plug!**

If the electrical connections are not made immediately after mechanical installation, close the open cable fittings temporarily to prevent moisture entering.

### 5.3 Hole pattern

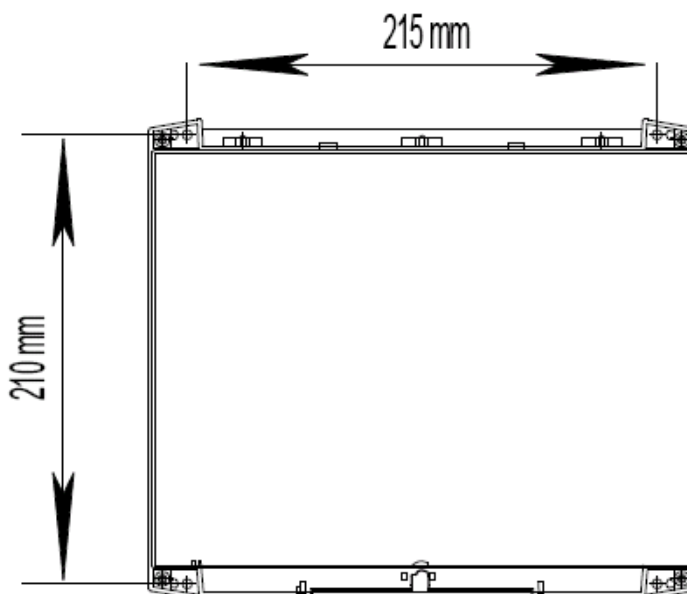



### 5.4 Retrofitting a dynamic pressure measurement module

The optional dynamic pressure measuring module can be installed at any time according to the following procedures.

- Switch off main switch and disconnect control unit from the power supply from the device side.
  - Ensure that the voltage is zero.
  - Remove the upper left pre-cut access hole from the bottom of the casing. To do this, use a screwdriver to tap against the inside of the pre-cut area from the outside.
  - Attach the silicon hose on the connection side to the short thread of the bulkhead coupling and tighten the union nut.
  - Attach the other end of the silicon hose to the dynamic pressure measurement module.
  - Insert the dynamic pressure measurement module into the "pressure" plug (next to the level measurement access holes).
  - Tighten circuit board holders to fix the dynamic pressure measurement module.
  - Insert bulkhead coupling through the previously removed opening in the bottom of the casing and tighten the lock nut from outside
- Warning:** Ensure the bulkhead coupling does not turn when tightening the lock nut. Otherwise the silicon hose will start to twist and might start leaking.
- Screw union nut from the outside.



### 5.5 Retrofitting Zener barriers



Zener barrier(s) should be factory-installed. If retrofitting is necessary, the prescribed procedures must be followed and appropriate dividers may be required to provide the stipulated 5 cm safe clearance



**Warning:** During retrofitting, functional components may have to be dismantled. Improper use may cause damage that is not covered by the warranty. Installation should only be carried out by trained personnel.

#### Installation:

- Switch off main switch and disconnect control unit from the power supply from the device side.
- Ensure that the voltage is zero.
- Loosen the screw of the main switch button (do not screw it out completely) and push it down by tapping on it. This causes the internal cone to loosen, so that the button can be pulled off.
- Remove the four outer attaching screws from the front panel.
- Statically discharge your body by touching an earth potential.
- Lift the front panel on the right side and tip it to the left.
- **Warning:** Do not touch any electronic components.
- Pull the connector plug of the flat cable out of the front panel.
- Take off the front panel and place it with the side covered by the front panel film down on a dry, clean and statically discharged surface.
- For a two-pump control unit first push a divider onto the profile rail on the left next to the contactor K1. For a one-pump control unit this is not necessary.
- Snap one or at the most two Zener barriers onto the left-hand side of the profile rail (flush left).
- **Warning:** Terminals 3 and 4 (blue – HAZ) must point down towards the fittings and terminals 1 and 2 (red – SAFE) must point upwards.
- Now connect the positive terminal of the relevant level input with terminal 1 of the Zener barrier and the negative terminal with terminal 2.
- A blue wiring cable is needed to wire a digital input (HW, SW1, SW2) and a white wiring cable is needed to wire an analog input (4-20 mA). The wires of the analog wiring must be twisted.
- After completing the wiring, assemble the device in the reverse order.
- Now connect the relevant sensors to terminals 3 (positive) and 4 (negative) of the Zener barrier.

Fig. 2 Zener barriers in 1-pump operation  
- without divider -



Fig. 2 Zener barriers in 2-pump operation  
- with divider -



### 5.6 Retrofitting an accumulator



Accumulators should be factory-installed. In case retrofitting is necessary, the following prescribed procedures must be followed.



**Achtung! Warning:** During retrofitting, functional components may have to be dismantled. Improper use may cause damage that is not covered by the warranty. Installation should only be carried out by trained personnel.

#### Installation:

- Switch off main switch and disconnect control unit from the power supply from the device side.
- Ensure that the voltage is zero.
- Loosen the screw of the main switch button (do not screw it out completely) and push it down by tapping on it. This causes the internal cone to loosen, so that the button can be pulled off.
- Remove the four outer attaching screws from the front panel.
- Statically discharge your body by touching an earth potential.
- Lift the front panel on the right side and tip it to the left.
- **Warning:** Do not touch any electronic components.
- Pull the connector plug of the flat cable out of the front panel.
- Take off the front panel and place it with the side covered by the front panel film down on a dry, clean and statically discharged surface.
- Insert original accumulator (plug at the top) and hold in place with a cable ties.
- Make the electronic connections using the original cable set.
- Connect the short cable with the blue flat plug socket to the plug of the circuit board (accumulator -) and then to the accumulator plug (black -).
- Connect the cable with the red flat plug socket and the red circular connector to the battery plug (red +).
- Connect the cable with a red flat plug socket and the red circular plug to the plug on the circuit board (Accu +).
- Connect the two circular plugs with each other.
- After completing installation and wiring, assemble the device in the reverse order.

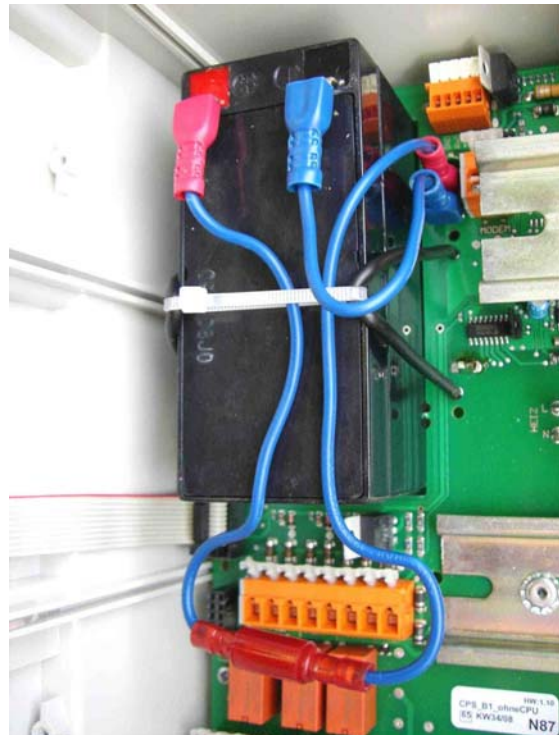

# Operating manual

## Basis pump control CPSB



### 6. Electrical Connection

The electrical connection of the control unit depends on its configuration and desired functionality. The presented connection systems are based on standard connections. Please turn to the relevant chapters for special wiring instructions.

#### 6.1 Connection diagram

Connection diagram for 1-pump and 2-pump control units.  
(Level measurement, potential-free contacts, 230V outputs)

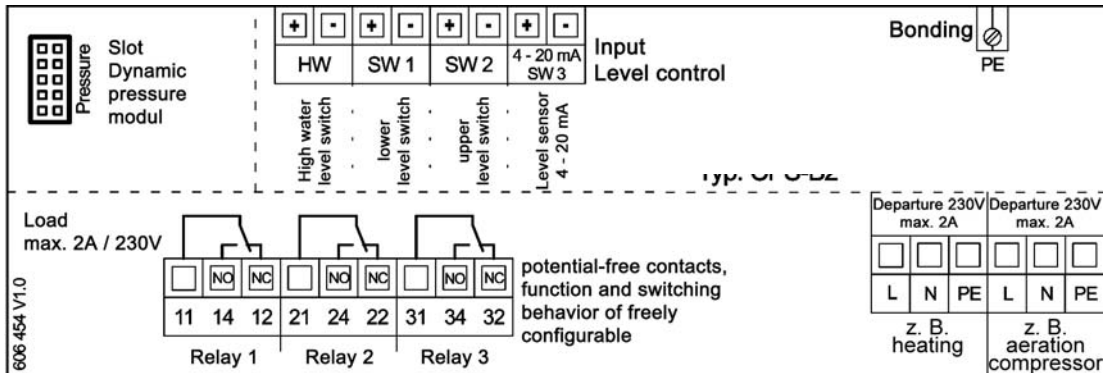

Connection diagram for connecting the motor and supply for **400V version**:  
(the motor cable is connected directly to the contactor)

1-Pump control

2-Pump control

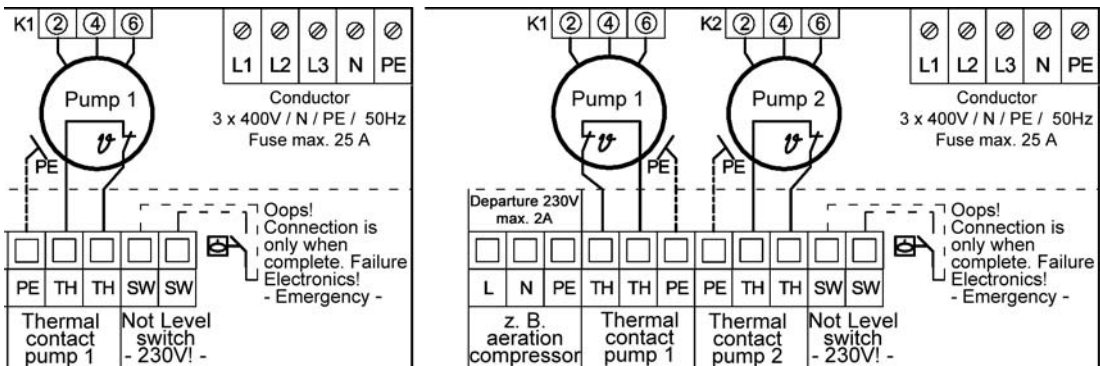

Connection diagram for connecting the motor and supply for **230V version**:  
(the motor cable is connected directly to the contactor)

1-Pump control

2-Pump control

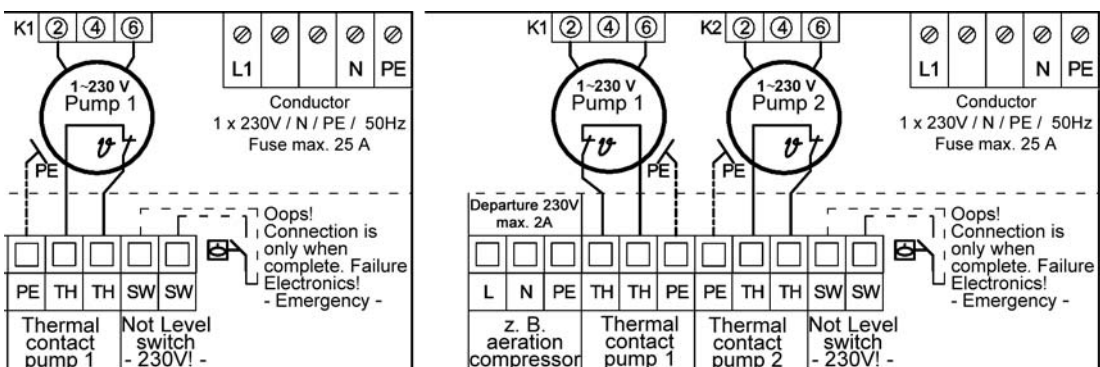

### 6.2 Terminal assignment

Order reference	Declaration	
Max. 6,3AT	Control safety of the control circuit and the 230V outlets	
	<b>Conductor / voltage</b>	
L1/L2/L3/N/PE or L1/N/PE	400V 50Hz 230V 50Hz	Supply, max. Hedging 25A ( <b>400V Version</b> ) Supply, max. Hedging 25A ( <b>230V Version</b> )
	<b>Connection emergency floats</b>	
SW	Emergency floats 230V	Separate connection for emergency floats on failure of the electronics
	Port of the pump(s) P1 / P2	
K1 / K2 (2, 4, 6) or K1 / K2 (2, 6)	400V movement out 230V movement out	Connecting the motor cable to the respective pump <b>400V Vers.</b> Connecting the motor cable to the respective pump <b>230V Vers.</b>
PE	protective conductor terminal	Ground cable of the motor line
TH / TH	Thermal contact pump	Hardware shutdown with restart protection / Nullspg. safely
L/N/PE HEATING	230V movement out max.2A	Connection of an optional internal / external heating
L/N/PE KOMP	230V movement out.2A	Connection of an optional small compressor
	<b>Floating output contacts</b>	<b>Switching behavior and functionality parameterisable</b>
11 / 14 / 12	Relay 1	Standard setting: Common fault
21 / 24 / 22	Relay 2	Standard setting: Error pump(s)
31 / 34 / 32	Relay 3	Standard setting: Error High water
	<b>Level measurement inputs</b>	
HW +/-	separate High water level switch	
SW 1 +/-	Float switch 1	lower switching level and external disconnection
SW 2 +/-	Float switch 2	middle (upper) level switching or external alarm
4-20mA; SW 3 +/-	Analog input or float switch 3	Input for level sensor 4-20mA or upper switching level
PE	protective conductor terminal	10mm <sup>2</sup> / Local bonding
Pressure	Slot impact pressure module	Optional Upgrades for impact pressure sensing 0-2 mWS

### 6.3 Emergency float 230V

In case the electronics fail, a float switch can be connected here. Its contact closes when it floats and therefore directly switches on the contactor of pump 1 (for one-pump versions) or the contactor of pump 2 (for two-pump versions).

### 6.4 External shutdown / remote shutdown / dry run protection

If the control unit is set to the level measuring system dynamic pressure or level sensor 4-20mA, there is an option of stopping the control unit via the SW1 input and turning it to standby. Both pumps will switch off, if the input is closed. If the input is opened again the control unit starts up with the preset starting delay. If this function is activated, the second line of the display will read "external OFF".

### 6.5 External alarm<sup>1</sup>

If the control unit is set to the level measuring system dynamic pressure or level sensor 4-20mA, there is an option of activating an external alarm via the SW2 input. If the input is closed, an external alarm is activated. This is shown on the display. The switching behaviour of the pump(s) is not affected by this alarm. However, the alarm message can be transmitted like any other alarm via alarm relays or, if available, reported via the communication equipment (modem / SMS).

### 6.6 Connection of the level measurement when using a Zener barrier

If a Zener barrier is put between the level measurement input she get the name of the level input. Terminal 3 is the positive pole and terminal 4 is the negative pole.

<sup>1</sup> Only for 2-pump control units



## 7 Operation and Displays

### 7.1 Overview



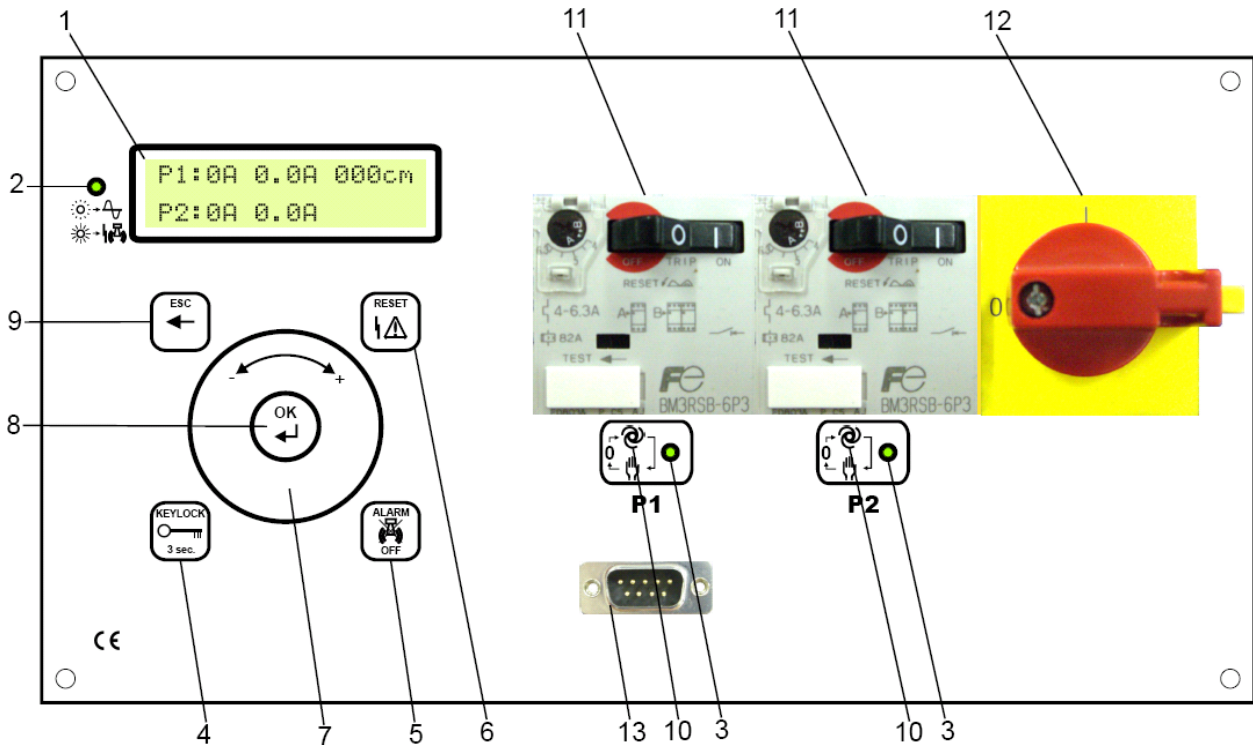

**Warning:** After turning on the power an automatic calibration of the sensor keys will be carried out. While the control unit is starting up, the sensor keys cannot be touched.

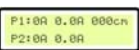

1.  Two-line display: Messages are presented in clear text on a two-line LCD display with 16 characters per line in the chosen language.









Graphic display: Messages are presented in clear text in the chosen language.

2. Green/red LED display "standby / collective fault":
- LED flashes green – normal operation
  - LED is red – collective fault
3.  Green/red LED display "operating mode and fault in the respective pump":
- LED is green = pump was switched on automatically
  - LED flashes red = pump was switched on or off by hand.
  - LED is red = pump has a fault.
4.  Keylock key: Warning: Operation is only possible if keylock is switched off. To do this the key must be pressed for at least 3 sec. After this time has elapsed the key symbol disappears from the display. If the keylock has been deactivated, it can be re-activated by pressing the button again for 3 sec. After a certain length of time with no input, the keylock is activated automatically.

# Operating manual

## Basis pump control CPSB



5.  Alarm off key: Pressing this key causes the internal acoustic alarm to switch off. Depending on the configuration, other alarm equipment, such as a warning light or horn are also switched off. This is the case if the alarm is switched via the existing potential-free relay contact and this is set to “Can be confirm – yes”.
6.  Reset key: Pressing this key resets repaired faults.
7.  Browse dial: By pressing and turning at the same time, it is possible to browse the different menus. It is also possible to make changes to values or parameter functions in an item on the menu.
8.  OK key: Pressing this key selects the chosen sub-menu or confirms changes to a parameter.
9.  ESC key: Pressing this button takes you immediately out of a sub-menu back to the Main Menu display or cancels an entry. Durch berühren der Taste gelangt man direkt aus einem Untermenü in die Hauptanzeige zurück, or bei einer Eingabe erfolgt hiermit ein Abbruch.
10.  Manual – 0 – automatic key: Each time this key is pressed, the operating mode of the respective pump switches between:
  - Automatic = pump switches on automatically if the level is exceeded.
  - Manual on = pump operates continuously; Warning: risk of running dry
  - Manual off = pump out of operation; Warning: risk of overflowingWarning: See message on the display: A = automatic, M = manual operation
11.  Motor circuit breaker: In each respective group of pumps the control unit has a motor circuit breaker, which provides short circuit or overload protection. Before start-up, the motor circuit breaker must be set to the nominal current of the pump.
12.  Main switch: The main switch allows you to switch off the power to the whole control unit. Only the input terminals and the main switch will still have power. When switched off, the main switch can be secured against switching on with a padlock.
13.  Interface: The control unit can be connected to a computer via the interface. Special programmes allow you to carry out a software update, for example.



**After changing parameters / menu settings the control unit may not recognise the changes, in which case it is necessary to re-start the control unit. Switch off the power supply and, if necessary, disconnect the 12V battery. Once the device is switched back on, all parameters will have been overwritten with the new data.**

### 7.2 Main display control with two-line display

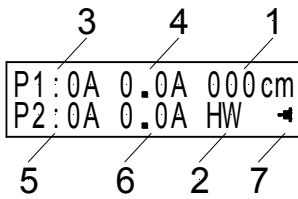

Fig.7.2.1 Display at 4-20mA or impact pressure

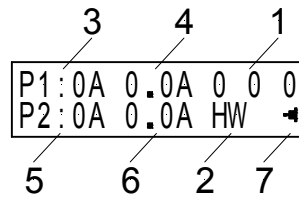

Fig. 7.2.2 Display at Float switch operation

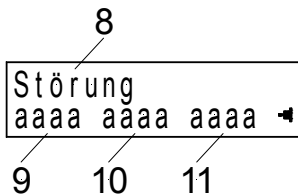



Fig.7.2.1 Display for faults

1. Level height in cm (for level measurement: 4-20mA or impact pressure  
or  
Float switch 1 - 3 (for level measurement: Float switch))
2. High water float switch
3. Operating status pump 1: 0 (A) Pump 1 is in automatic mode not controlled  
1 (A) Pump 1 is in automatic mode controlled  
1 (M) Pump 1 is in manual mode turned  
0 (M) Pump 1 is in manual mode off
4. Current consumption pump 1
5. Operating status pump 2: 0 (A) Pumpe 2 is in automatic mode not controlled  
1 (A) Pumpe 2 is in automatic mode controlled  
1 (M) Pumpe 2 is in manual mode turned  
0 (M) Pumpe 2 is in manual mode off
6. Current consumption pumpe 2
7. Symbol  flashes: Control in operation  
Symbol  : Control on battery

Failure mode, the display changes cyclically back and forth between the main display and the fault indicator and fro (see separate chapter "fault list).

8. Fault indication
9. Display of the first Error as an error code
10. Display of the second Error as an error code
11. Display of the third Error as an error code



### 7.3 Main display control with graph. display

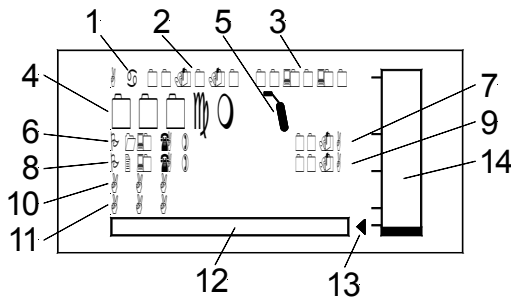

Fig.7.2.1 Display at 4-20mA or impact pressure

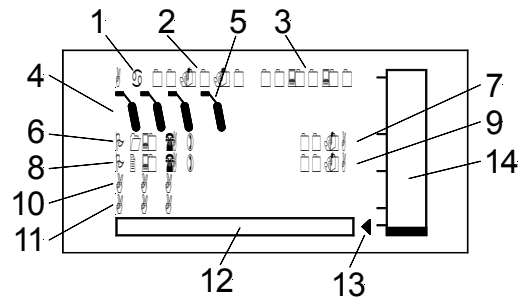

Fig. 7.2.2 Display at float switch operation

1. Day of the week
2. Date
3. Time adjustable
4. Level height in cm (for level measurement: 4-20mA or impact pressure (#065))  
or  
Float switch 1 - 3 (for level measurement: float switch (#065))
5. High water float switch
6. Operating status pump 1: 0 (A) Pump 1 is in automatic mode not controlled(#033)  
1 (A) Pump 1 is in automatic mode controlled (#033)  
1 (M) Pump 1 is in manual mode turned (#033)  
0 (M) Pump 1 is in manual mode off (#033)
7. Current consumption pump 1
8. Operating status pump 2: 0 (A) Pump 2 is in automatic mode not controlled(#034)  
1 (A) Pump 2 is in automatic mode controlled (#034)  
1 (M) Pump 2 is in manual mode turned (#034)  
0 (M) Pump 2 is in manual mode off (#034)
9. Current consumption pump 2
10. Fault indication
11. Modem indication
12. Symbol field (see also section symbol definition)
13. Symbol flashes: Control in operation
14. graph. level control (for level measurement:: 4-20mA or impact pressure (#065))

### 7.4 Pump operating mode

The pump operating modes can be switched between automatic, manual ON and manual OFF via the relevant key.



If the pump(s) is(are) switched to manual ON, it (they) is(are) only in operation if there is no pump fault. If in two-pump operation one pump is switched to OFF, the control unit continues to operate as a one-pump control unit if the other pump is set to "automatic".



Standard configuration for manual operation: If for the basic configuration the function STD (standard) is selected for the number of pumps, the pumps are not switched off automatically if they run dry during manual operation. It is the operator's responsibility to prevent pumps from running dry. However, the function of the thermal contacts is still maintained. This means that if the thermal contacts open (high temperature), manual operation is not possible.



Manual operation in ATEX mode: If for the basic configuration the function (ATEX) is selected for the number of pumps, the pump only operates until the lower cut-off point has been reached. The operating mode then reverts to automatic operation.



If the manual off "0M" operating mode is selected, the pump is completely switched off.  
**Warning: Danger of flooding. The pump will not be switched on if there is a High water alarm.**

### 7.5 Using a 2-pump control unit as a 1-pump control unit

Each 2-pump control unit can also be used as a 1-pump control unit. This is achieved by setting the number of pumps, found in the basic configuration menu, to "1". This effectively turns it into a normal 1-pump control unit, whereby the 2nd pump "P2" is no longer active. The thermal contact input for the unused pump must be bridged and the motor circuit breaker must remain switched on.

Authorised personnel also have the option of setting the device from two to one pumps in the factory settings. In this case it is important to make sure that pump "P2" (right connection) is the pump that is being controlled. Pump "P1" (left connection) is then no longer active.

### 7.6 Messages after system start-up

When the control unit is switched on, it first tests the program memory. A number of messages appear concerning the internal configuration, state of the software, etc., followed by a control unit self-test. After a starting delay period, the control unit starts up automatically.

\* In normal operation (measuring system functioning), the status of the relevant pump(s) remains "on" until the cut-off point of each pump has been exceeded. If the measuring system is "faulty", the pumps are switched off if the level sinks below the High water activation point.

### 8 Functional description

#### 8.1 Level measurement methods

The control unit can be operated using different methods of level measurement:

##### 1. External level sensor

- Measuring range up 0 ... 1m WS to 0 ... 10mWS / Water level (adjustable)
- 4... 20mA Output signal
- Additionally, a float switch as a high-water monitor

This method uses a pressure measurement cell in a sealed container that is suspended in the medium. The level pressure acts directly on the piezo sensor and is transmitted via a cable as an analog electrical signal of 4-20mA. As an extra safety precaution, an additional High water float should also be used, which switches the pump(s) on if a certain High water mark is reached and turns the pumps off again once the level is below this mark.

1. Level sensor
2. Float switch                      High-water

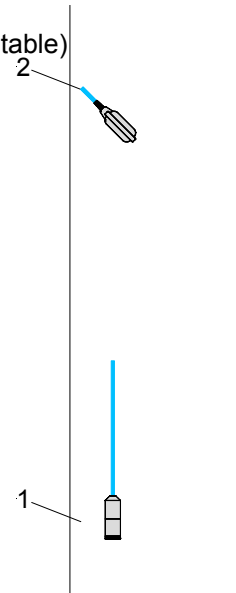

##### 2. Impact pressure level sensor

- Measuring range 0 ... 2 m WS
- For connection of a wet bell with a pneumatic tube
- Additionally, a float switch as a high-water monitor

With the dynamic pressure measurement system, a pressure change occurs in the measurement system when the water level changes. This pressure difference is detected by the control unit's sensors, which use it to determine the water level. As an extra safety precaution, an additional High water float should also be used, which switches the pump(s) on if a certain High water mark is reached and turns the pumps off again once the level is below this mark.

1. Wet bell
2. Float switch                      High-water

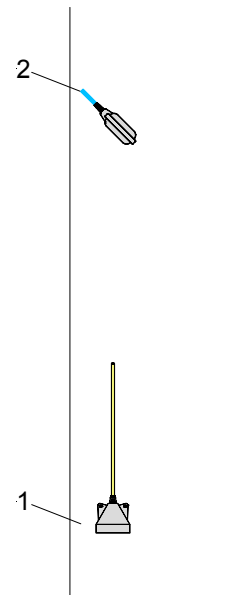

# Operating manual

## Basis pump control CPSB



### 3. Float switch

Depending on the water level and whether the float switch is activated, the pump(s) is(are) switched on or off. As an extra safety precaution, an additional High water float should also be used, which switches the pump(s) on if a certain level is reached, regardless of the activation status of the general float switch.



**Due to the use of low voltage should only swim with gold contacts are used! If the float switch in the ATEX area used, they must also intrinsically a circuit, eg be operated by means of Zener barrier.**

Operating mode	One Float switch	Two Float switches	Three Float switches
One pump operation	●	●	-
Two-pump operation	-	●	●
1/1- pump operation	●	●	-

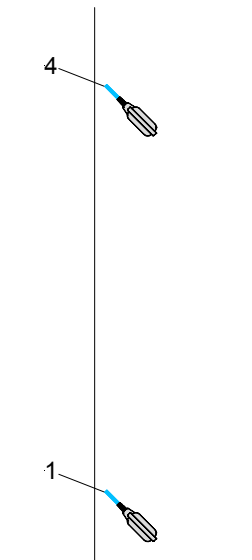

Fig. One-pump control with a float switch

- 1. Float switch 1
- 2. Float switch 2
- 4. Float switch High water

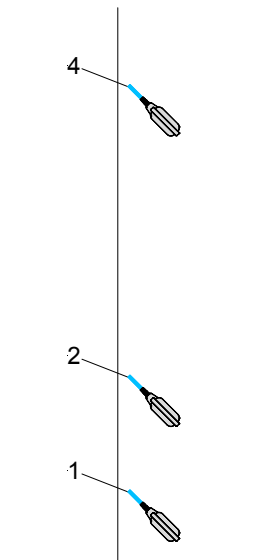

Fig. One-pump control with two float switches

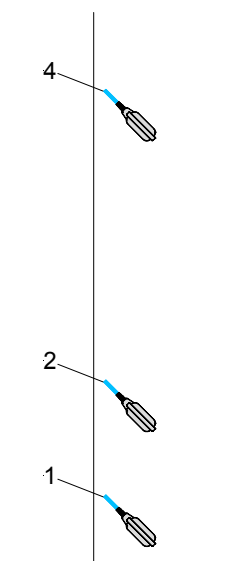

Fig. Two-pump control with two float switches

- 1. Float switch 1
- 2. Float switch 2
- 3. Float switch 3
- 4. Float switch High water

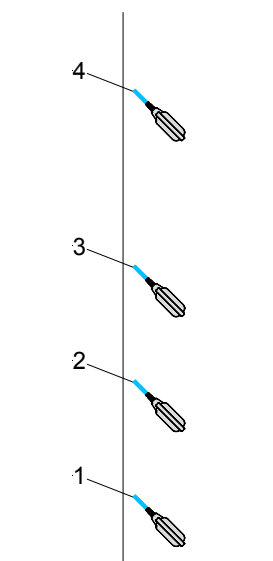

Fig. Two-pump control with three float switches

## 8.2 Pump control

### Pump control for normal operation

The control unit can operate with either one or two pumps. Generally, the following procedure applies: if the medium rises above an (adjustable) level, the pump is switched on. If the medium sinks below an (adjustable), level the pump is switched off.

### Pump control for High water operation

#### a) Evaluation via a level measuring system:

When the predetermined High water level (alarm level) has been exceeded, the corresponding pump(s) is(are) switched on. This is followed by a visual and acoustic alarm signal. Depending on the setting of the alarm masks, an additional alarm signal can be sent via a potential-free contact. Once the medium goes below the alarm and deactivation level the pump(s) is(are) switched off again.

#### b) Evaluation via a separate High water float and a functioning level measuring system:

If the separate High water float is activated, the relevant pump(s) is(are) switched on. This is followed by a visual and acoustic alarm signal. Depending on the setting of the alarm masks, an additional alarm signal can be sent via a potential-free contact. Once the float switch has been switched off and the medium sinks below the deactivation level, the pump(s) is(are) switched off again.

#### c) Evaluation via a separate High water float and a faulty level measuring system:

If the separate High water float is activated, the relevant pump(s) is(are) switched on. This is followed by a visual and acoustic alarm signal. Depending on the setting of the alarm masks, an additional alarm signal can be sent via a potential-free contact. After switching off the float switch, the pump(s) is(are) switched off again.



**Wir empfehlen jede Anlage mit einem Hochwasserfloat switch auszustatten, da eine Beeinträchtigung des normalen Niveaumesssystems zu einer Überflutung führen kann. Wenn eine Steuerung ohne Hochwasserfloat switch betrieben wird, werden wir für etwaige Folgeschäden, aufgrund defekter Niveauerfassung, keine Kosten übernehmen.**

## 8.3 Fault messages and alarms

In addition to the fault messages associated with the pumps (see "Fault list" section), the control unit monitors whether the following faults have occurred:

- High water
- Loss of mains phase or phase error (wrong phase sequence)
- Faults in the measurement system (short circuit or interruption in the cables connecting the level sensor, inconsistent activation status of the float)
- Loss of control voltage
- Accumulator voltage too low
- Additional "AUX" alarm per pump
- "External" error (only 2-pump control units with continuous level assessment)

Faults are indicated via a red LED, a built-in buzzer or via up to three potential-free alarm relays.

The control unit has three alarm relays, via which the alarms can be flexibly distributed. It is possible to programme which alarm(s) are associated with which relay as well as the activation sequence of the relay contacts.

### 8.4 Pump activation sequence

The activation levels determine when the pump(s) is(are) switched on or off. If the control unit is run with a continuous level measuring system (level sensor or dynamic pressure system), the measured levels are directly processed and analysed. If the control unit works with a float, the activation state of the float determines whether the pump(s) are activated.

For consistent level values, the following conditions must be fulfilled:

- a) The highest set level must be lower than the set measurement range of the level measuring system.
- b) For one-pump control units and alternating two-pump control units:  
Deactivation level of 1st pump < activation level of 1st pump < alarm level
- c) For two-pump control units (peak load operation):  
Deactivation level of 1st pump < deactivation level of 2nd pump < activation level of 1st pump < activation level of 2nd pump < alarm level

The High water alarm is triggered if a level higher than the alarm level is measured.

The following tables show the activation sequence of two-pump control units in peak load operation mode and the one-pump control unit or two-pump control unit in alternating mode with continuous level measurement and with floats.



**The basic principle is: If a deactivation signal is given due to a change in level or because a change in the position of the float, the pump does not switch off immediately. It switches off after an optionally adjustable shutting down time has expired.**

### 1. Switching behavior level- and impact pressure measurement methods:

#### One-pump operation and 1/1- Operation:

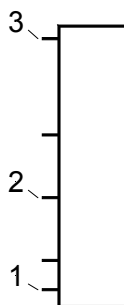

Pos.	Definition
1	Switch-off-point 1 pump
2	Switch-on-point 1 pump
3	High water level

#### Two-pump operation:

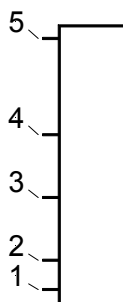

Pos.	Definition
1	Switch-off-point 1 pump
2	Switch-off-point 2 pump
3	Switch-on-point 1 pump
4	Switch-on-point 2 pump
5	High water level

# Operating manual

## Basis pump control CPSB



### 1.1.1 Increasing level at single-pump operation:

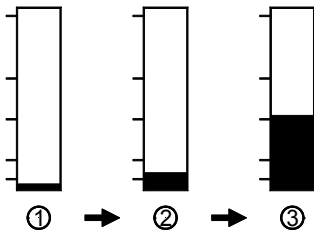

Pos.	Description	Status pump
①	Level below the switch-off-point 1 pump	Off
②	Level exceeds the switch-off-point 1 pump	Off
③	Level exceeds the switch-on-point 1 pump	On

### 1.1.2 Falling level at single-pump operation:

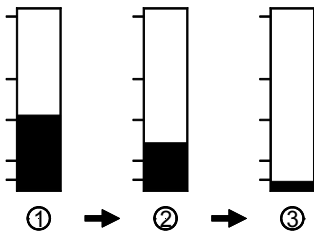

Pos.	Description	Status pump
①	Level above the switch-on-point 1 pump	On
②	Level below the switch-on-point 1 pump	On
③	Level below the den switch-off-point 1 pump	Off

### 1.2.1 Increasing level at two-pump operation:

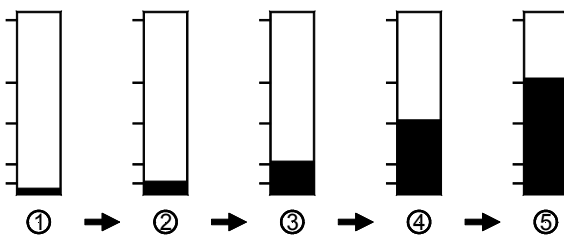

Pos.	Description	Status first pump	Status second pump
①	Level below the switch-off-point 1 pump	Off	Off
②	Level exceeds the switch-off-point 1 pump	Off	Off
③	Level exceeds the switch-off-point 2 pump	Off	Off
④	Level exceeds the switch-on-point 1 pump	On	Off
⑤	Level exceeds the switch-on-point 2 pump	On	On

# Operating manual

## Basis pump control CPSB



### 1.2.2 Falling level at two-pump operation:

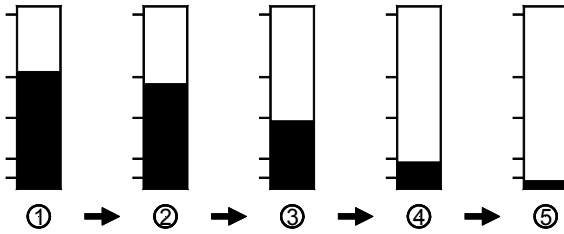

Pos.	Description	Status first pump	Status second pump
①	Level above the switch-on-point 2 pump	On	On
②	Level below the switch-on-point 2 pump	On	On
③	Level below the switch-on-point 1 pump	On	On
④	Level below the switch-off-point 2 pump	On	Off
⑤	Level below the switch-off-point 1 pump	Off	Off

### 1.3.1 Increasing level at 1/1- pump operation:

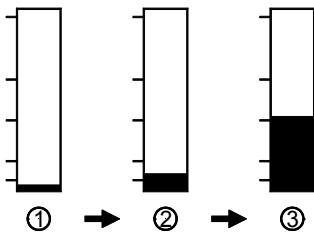

Pos.	Description	Status first pump	Status Second pump
①	Level below the switch-off-point 1 pump	Off	Off
②	Level exceeds the switch-off-point 1 pump	Off	Off
③	Level exceeds the switch-on-point 1 pump	On	Off
		Off	On

### 1.3.2 Falling level at 1/1- pump operation:

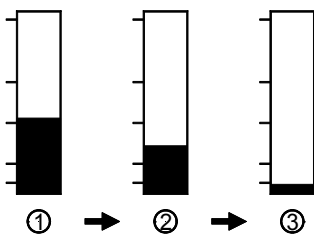

Pos.	Description	Status first pump	Status second pump
①	Level above the switch-on-point 1 pump	On	Off
		Off	On
②	Level below the switch-on-point 1 pump	On	Off
		Off	On
③	Level below the switch-off-point 1 pump	Off	Off



# Operating manual

## Basis pump control CPSB



### 1.4.1 Rising/falling level over set High water level:

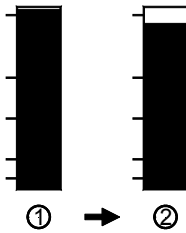

Pos.	Description	Operating mode	Status first pump	Status second pump
①	Level above the High water switch-on-point	One pump operation	On	-
②	Level below the High water switch-on-point	One pump operation	Off *	-
①	Level above the High water switch-on-point	Two-pump operation	On	On
②	Level below the high High water switch-on-point	Two-pump operation	Off *	Off *
①	Level above the High water switch-on-point	1/1- pump operation	On or Off	Off On
②	Level below the high High water switch-on-point	1/1- pump operation	Off *	Off *

\* during normal operation (measurement system functional) the relevant pump(s) remain(s) set to "on" until the level falls below the deactivation point of the relevant pump. If the measurement system is "faulty", the pumps are switched off after the level falls below the High water activation level.

# Operating manual

## Basis pump control CPSB



### 2. Switching behavior Float switches:

#### 2.1.1 Increasing level for one-pump operation with a float switch:

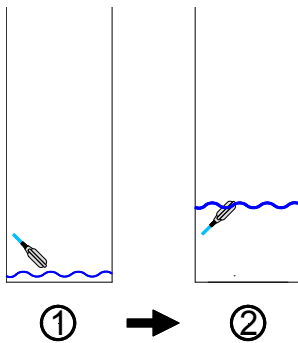

Pos.	Float switch	Status pump
①	not switched	Off
②	switched	On

#### 2.1.2 Falling level for one-pump operation with a float switch:

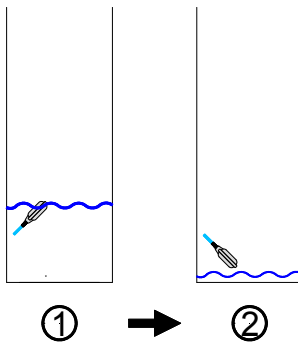

Pos.	Float switch	Status pump
①	switched	Off
②	not switched	On

#### 2.2.1 Increasing level for one-pump operation with two float switches:

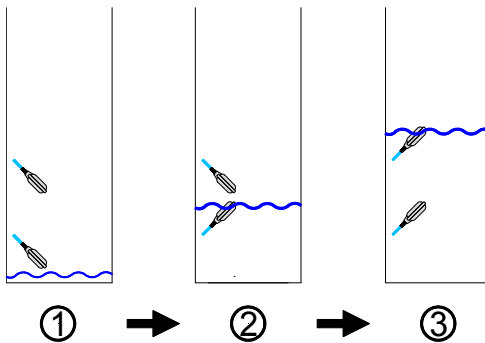

Pos.	First float switch	Second float switch	Status pump
①	not switched	not switched	Off
②	switched	not switched	Off
③	switched	switched	On

#### 2.2.2 Falling level for one-pump operation with two float switches:

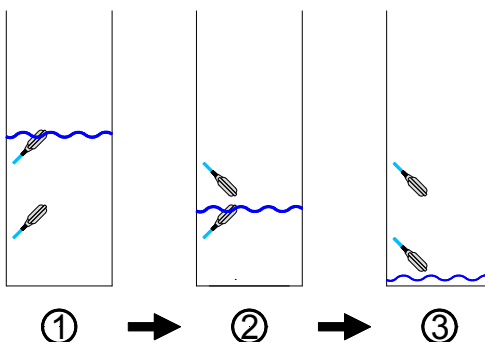

Pos.	First float switch	Second float switch	Status pump
①	switched	switched	On
②	switched	not switched	On
③	not switched	not switched	Off

# Operating manual

## Basis pump control CPSB



### 2.3.1 Increasing level for two-pump operation with two float switches:

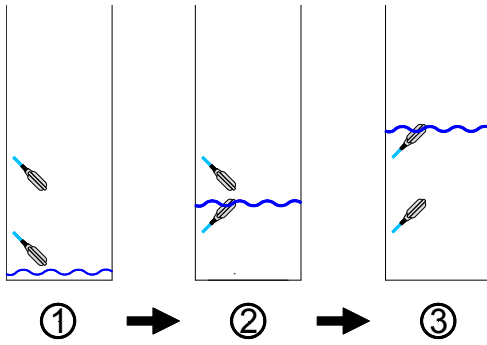

Pos.	First float switch	Second float switch	Status first pump	Status second pump
①	not switched	not switched	Off	Off
②	switched	not switched	On	Off
③	switched	switched	On	On

### 2.3.2 Falling level for two-pump operation with two float switches:

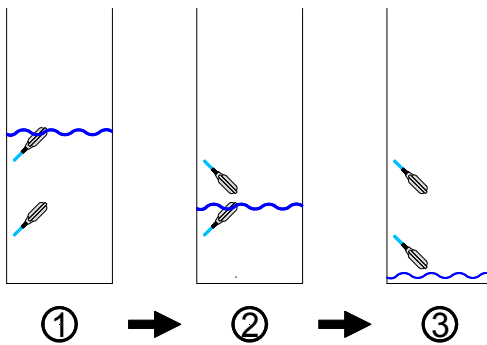

Pos.	First float switch	Second float switch	Status first pump	Status second pump
①	switched	switched	On	On
②	switched	not switched	On	On
③	not switched	not switched	Off	Off

### 2.4.1 Increasing level for two-pump operation with three float switches:

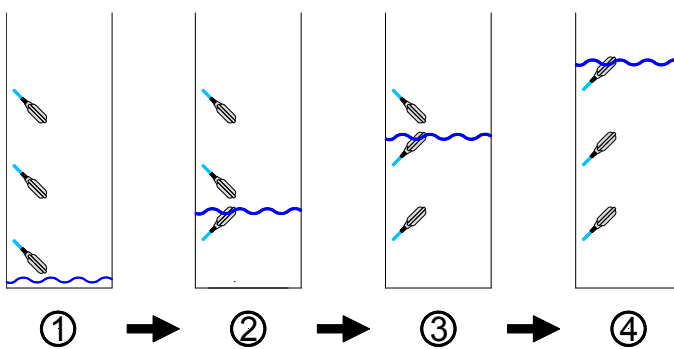

Pos.	First float switch	Second float switch	Third float switch	Status first pump	Status second pump
①	not switched	not switched	not switched	Off	Off
②	switched	not switched	not switched	Off	Off
③	switched	switched	not switched	On	Off
④	switched	switched	switched	On	On

# Operating manual

## Basis pump control CPSB



### 2.4.2 Falling level for two-pump operation with three float switches:

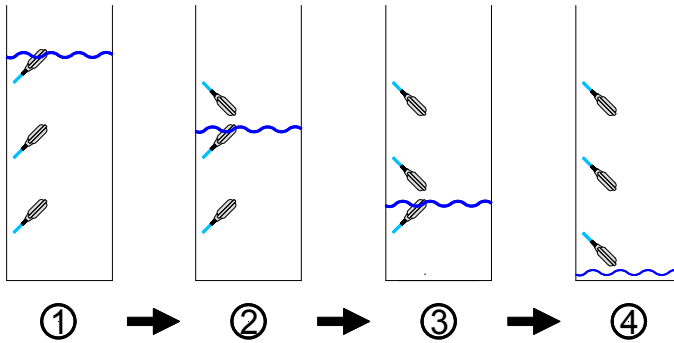

Pos.	First float switch	Second float switch	Third float switch	Status first pump	Status second pump
①	switched	switched	switched	On	On
②	switched	switched	not switched	On	On
③	switched	not switched	not switched	On	Off
④	not switched	not switched	not switched	Off	Off

### 2.5.1 Increasing level for 1/1-pump operation with a float switch:

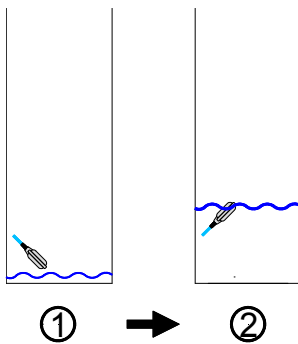

Pos.	Float switch	Status first pump	Status second pump
①	not switched	Off	Off
②	switched	On	Aus
		Off	On

### 2.5.2 Falling level for 1/1-pump operation with a float switch:

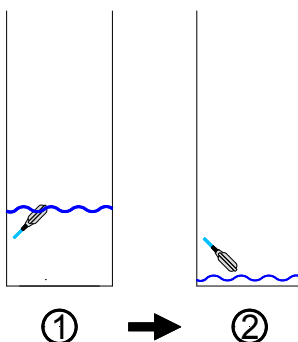

Pos.	Float switch	Status first pump	Status second pump
①	switched	On	Off
		Off	On
②	not switched	Off	Off

# Operating manual

## Basis pump control CPSB



### 2.6.1 Increasing level for 1/1-pump operation with two float switches:

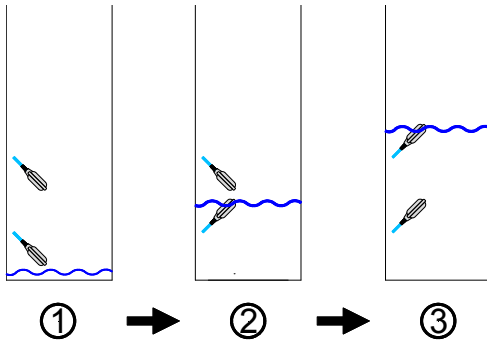

Pos.	First float switch	Second float switch	Status first pump	Status second pump
①	not switched	not switched	Off	Off
②	switched	not switched	Off	Off
③	switched	switched	On	Off
			Off	On

### 2.6.2 Falling level for one-pump operation with two float switches:

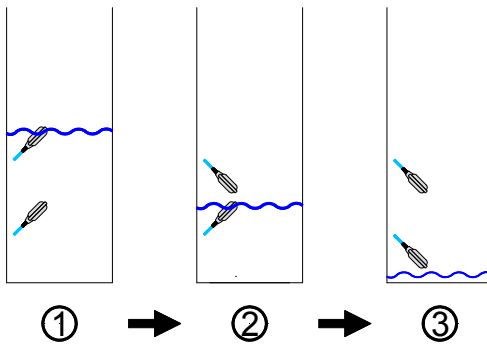

Pos.	First Operating mode	Second float switch	Status first pump	Status second pump
①	switched	switched	On	Off
			Off	On
②	switched	not switched	On	Off
			Off	On
③	not switched	not switched	Off	Off

### 2.7.1 Increasing / falling level of adjusted High water level with HW-float switch:

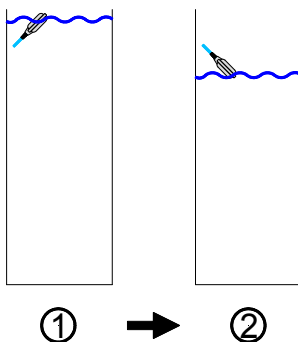

Pos.	HW – float switch	Operating mode	Status first pump	Status second pump
①	switched	One pump operation	On	-
②	not switched	One pump operation	Off *	-
①	switched	Two-pump operation	On	On
②	not switched	Two-pump operation	Off *	Off *
①	switched	1/1- pump operation	On	Aus
			Off	On
②	not switched	1/1- pump operation	Off *	Off *

\* during normal operation (measurement system functional) the relevant pump(s) remain(s) set to "on" until the level falls below the deactivation point of the relevant pump. If the measurement system is "faulty", the pumps are switched off after the level falls below the High water activation level.

### 9 On site fuse protection

The power supply of the control unit must be protected on site by appropriate all-pole pre-fusing according to the current values of the control unit. The maximum permitted values can be found in the appropriate circuit diagram. The tripping characteristic must be adjusted to the local conditions.

#### 9.1 Main switch

The control unit has a main switch. The control unit can therefore be switched on and off via the main switch. The main switch has an emergency shut-off function and switches the pumps off. The main switch can be locked into the OFF position with a padlock.



**Note: Even when the main switch is off, the terminals before the main switch are still live**



**If the control unit is equipped with an accumulator, the control unit electronics continue to function even when the main switch is off, as long as the accumulator is charged; the pumps, however, are no longer in operation.**



**Important for ATEX areas**

**According to DIN EN 60079-14, there must be a mechanism for turning off the electricity in an appropriate place outside the explosion hazardous area in case of emergency. This can be achieved, for example by using a main switch.**

#### 9.2 Motor circuit breaker

The control unit has one motor circuit breaker per pump. The current value is set directly on the motor circuit breaker in accordance with the specifications of the relevant pump (identification plate). This setting is carried out independently of the nominal current settings of the electronic motor protection in the control unit.

If motor protection is triggered by an overload, a fault is displayed in the control unit. The motor circuit breaker must be switched back on manually once the fault is removed.

The nominal current is not normally set in the pump data menu, except if the nominal current of the pump is lower than the lowest possible nominal current setting of the motor circuit breaker. This should only be carried out on control units where the pumps are located in a non-ATEX area. Otherwise the motor circuit breakers should be adjusted to the nominal current of the pumps.

### 9.3 Accumulator

The control unit can run on an accumulator, allowing it to carry on operating in the event of a power failure. The device continues to carry out level measurements, transmit alarm messages, maintain optical displays and it is possible to alter settings and parameters in the menu. However, the pumps no longer function.



**The polarity of the accumulator will affect how it is connected. (read connecting wire = +; blue connecting wire = -). If the polarity is wrong, the accumulator and control unit may be destroyed.**



**It is important to prevent disconnected connecting cables from touching a different voltage potential (e.g. circuit board connections).**



**IMPORTANT: Please note the section on retrofitting an accumulator**



**Batteries / accumulators should not be thrown out with household rubbish. Consumers are legally obliged to return used batteries / accumulators. Old batteries / accumulators can be returned to the public collection points provided by the local government.**

To connect an accumulator that is already installed, the red circular connectors (see picture) of the +12V cable must be connected together. To disconnect the emergency power supply, the red circular connectors of the +12V cable must be disconnected.

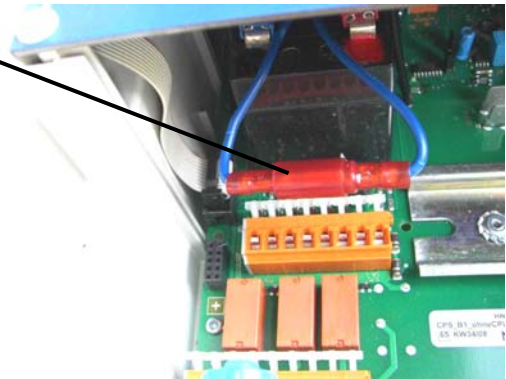

### 9.4 Intrinsically safe circuits

Intrinsically safe circuits are necessary to fulfil explosion protection requirements with regard to the separation of circuits. This separation is intended to prevent the entry of energy, voltage or current capable of causing ignition in an explosive atmosphere.



**The control unit must not be installed in an explosion hazardous area, but only in so-called safe areas.**

To prevent the evaluation electronics igniting in the hazardous area, the activation circuit of the sensor includes a Zener barrier or isolating switching amplifier, whereby the intrinsically safe circuit can run separately from the safe area into the explosion hazardous area.



**IMPORTANT: Please note the section on retrofitting Zener barriers**

### 9.5 Thermal contacts / coil protection contacts (Klixon or bimetallic)

In general, wastewater pumps have one or two thermal contacts (Klixon) that are activated at different temperatures. Activation of the thermal contact causes a fault and stops the pump. This alarm lasts until the operator has manually switched it off, even if the pump has cooled down in the meantime. The fault remains even if there is a total failure of the power supply.

The control unit has an option of testing a thermal contact. If it is necessary to test two thermal contacts on one pump, the two contacts have to be connected in series.

### 9.6 Thermal contacts as PTC thermistors

If the pump(s) have PTC thermistors to monitor the maximal allowable temperature, these cannot be connected directly to the controllers. It is necessary to interconnect PTC test relays.

### 9.7 Monitoring impermeability/ moisture sensor

If the pump(s) have an impermeability monitor, it cannot be directly connected to the controller. It is necessary to interconnect impermeability testers (electrode relays).

### 9.8 Compressor or agitator

Depending on the menu setting, it is possible to control an additional compressor or agitator via the control unit. The first alarm relay, as well as the external alarm input, is then no longer available. The compressor or agitator can be chosen to run before/after the pumps or in parallel with them. It is possible to programme them to switch on at regular intervals or at a certain time of day. How long they are switched on can be regulated separately. The compressor or agitator is always controlled via alarm relay 1 of the control unit. If the control unit starts the compressor, the relay starts up. The external alarm input (input float 2) serves as a fault message input for the compressor or the agitator. A closed input is interpreted as a fault. If the bimetallic relay of the compressor is activated, for example, the fault message "RW/external" is shown and the compressor switches off. Other functions are not affected.



**If, for example, a refill compressor is activated via this function and the local conditions or the functional specifications require that this should not occur at the same time as pumping, then the hardware must prevent the refill compressor from being driven during pumping.**





### 9.9 Communication

A control unit equipped with a communication function can:

- send an SMS message to a recipient if a fault occurs or on demand.
- set up data communication via the Watertel protocol with a PC and exchange all control parameters and values with it when a fault occurs.
- be called up by a PC with an appropriate modem, to exchange data.
- exchange data and parameters with a PC via a direct serial connection.

The communication of the CPS module can occur via:

- a GSM modem.
- a serial connection (V24/ RS232C).

For voice messages an additional TTS voice module is required.

#### **Prerequisites for using a GSM modem:**

- an unlocked, data and SMS-compatible SIM card for the D or E network *Caution: only use 3V SIM cards*
- the CPS module / antenna is set up in a location with adequate reception field strength.

#### **Prerequisites for using a direct PC connection:**

- a serial connection cable (null modem cable).
- a free COM port on the PC.

# Operating manual

## Basis pump control CPSB



### 10 System menu / parameter settings for a control unit with a two-line display

#### 10.1 Overview Main Menu

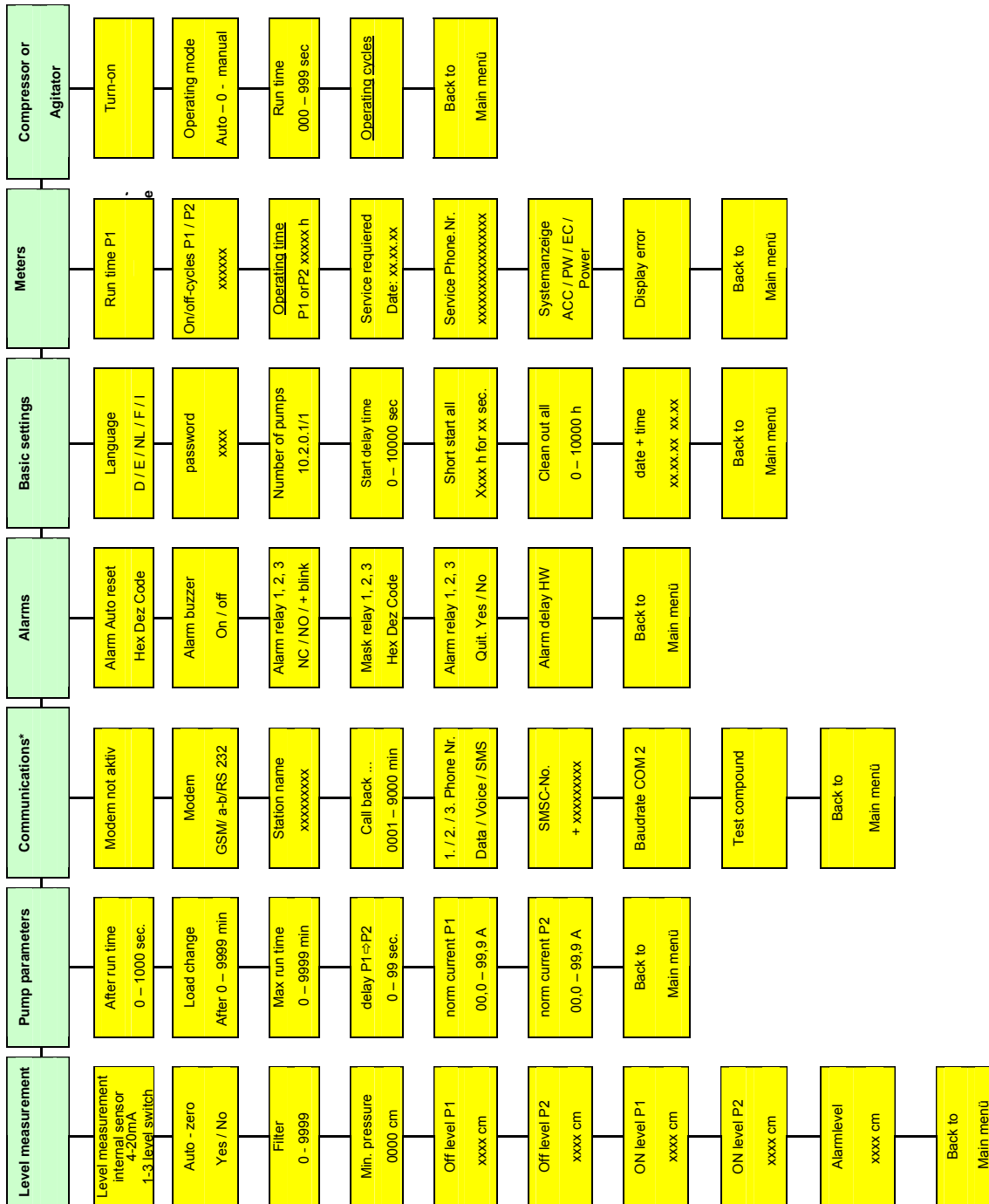

\*Only for release

\*\*No input possible

### 10.2 Sub-menu „Level measurement method“

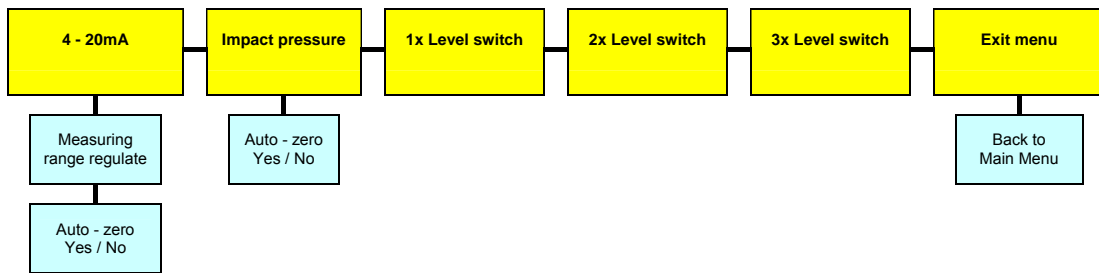

**Choice of measuring method:** This menu item allows you to choose the measuring method.

- Level measurement: 4... 20mA Interface over Level sensor
- Impact pressure (measuring range 0 ... 200cm WS)
- 1x float switch
- 2x float switch
- 3x float switch (only in two-pump operation possible)

If 4-20mA (Level sensor) is selected as the measuring method, the measuring range of the attached sensor must be entered in cm after selecting the measuring method.

**The following sub-menus are only activated if measuring system “4-20mA” and “dynamic pressure” are selected:**

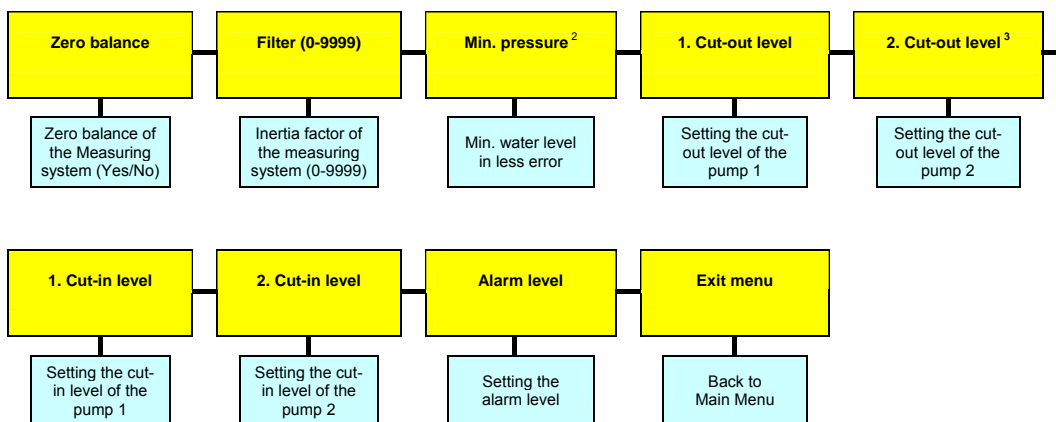

**Zero balancing:** This menu item carries out a zero balancing adjustment of the measuring system used. During balancing, the measuring system cannot be in the water. Ensure that the measuring system is kept still during the balancing procedure. Zero balancing can be repeated at any time.

**Filter:** For widely fluctuating water levels, the level display may become unstable. By using a low-pass filter, it is possible to compensate for this, making the level assessment more sluggish.

“0000” = filter OFF, “0001” = weak (rapid) filter ... “9999” strong (slow) filter

<sup>2</sup> only displayed when using the “dynamic pressure” measuring system.

<sup>3</sup> only displayed if menu item (#131) is set to 2 pumps.

# Operating manual

## Basis pump control CPSB



**Warning:** If a filter is switched on, the level display may become so sluggish that the measured level differs significantly from the actual level in the shaft. The shaft may already be empty, whereas the measured value shows a level above the deactivation value, meaning the pump can run dry. Pump performance, activation levels and filter values therefore have to be carefully adjusted in relation to each other.

**Note:** Not necessary for normal applications.

**Minimum pressure<sup>4</sup>:** This menu item allows you to set a minimum pressure for the measuring system in cm. The value entered can be monitored by the control unit. If the level measurement sinks below the set pressure, a fault message is issued. If the value is set to "0000cm", the minimum pressure monitoring system is switched off. This function can also be used if the level should not fall below a certain minimum level or if air bubbles from a small compressor need to be monitored.

**1st deactivation level; 2nd deactivation level<sup>5</sup>:** This menu item allows you to set the respective deactivation levels of the pump in cm. The values must be adjusted to the specific local conditions.



**Warning:** The deactivation levels must be lower than the activation levels ("OFF" < "ON"). The control unit automatically checks these values against the values for the activation levels. If the levels are incorrect, the display of the "Level measurement" sub-menu displays a "?". The values entered must be corrected.

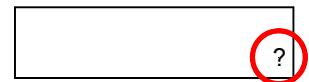

The lowest cut-off level must be set to at least 001 centimetres, since the control unit only switches off the pump if it goes below the set value.

**1st activation level; 2nd activation level<sup>6</sup>:** This menu item allows you to set the respective activation levels of the pumps in cm. The values must be adjusted to the specific local conditions.

**Alarm level:** This menu item allows you to set the alarm level. The value must be adjusted to the specific local conditions.

**Exit menu:** Back to the Main Menu.

<sup>4</sup> only displayed if menu item (#131) is set to 2 pumps.

<sup>5</sup> only displayed if menu item (#131) is set to 2 pumps.

<sup>6</sup> only displayed if menu item (#131) is set to 2 pumps.

### 10.3 Sub-menu „Pump data”

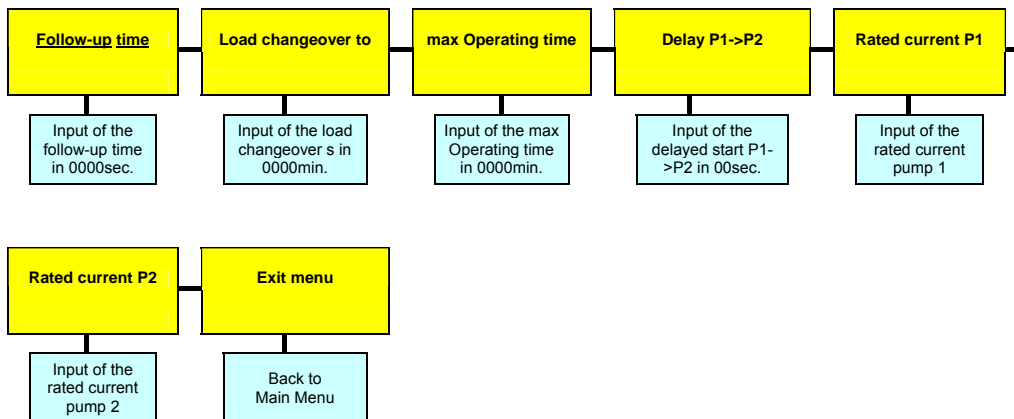

**Run-on time:** This menu item allows you to set the run-on time of the pumps in sec. This is the time the pumps will continue to operate after the deactivation level has been exceeded. The setting range is freely adjustable between “000 – 9999sec”. A value of “0000sec.” switches off this function.



**If the run-on time is too long, the pumps may run dry and be damaged as a result.**

**Load alternation after...:** This menu item allows you to set the load alternation behaviour of the control unit in minutes. If a value of “0000min.” is set, the load alternation is only carried out after both pumps have been switched off. If a value between “0001 and 9998min.” is selected, load change occurs after both pumps switch off, but at the latest after the time set here. A value of “9999min.” switches off the load alternation function, meaning the control unit generally starts with pump 1 and that pump 2 is always the peak load pump.



**Warning: If in menu item #131 the operating mode 1/1 is selected, a value of “9999min.” means that pump 2 never switches on automatically.**

**Max. running time:** This menu item allows you to limit the max. running time of the pump to a time between “000-999min.” If the pump(s) is(are) activated continuously for longer than the time set here, it(they) is switched off and an alarm is triggered. In a two-pump control unit where one pump is activated, the control unit will switch to the other pump once the time has elapsed and an alarm is triggered. When the pump that has just switched on also reaches the running time limit, it is switched off and a further alarm is activated. A value of “0000min.” switches off this function.

**P1->P2 delay:** This menu item allows you to set the delay time between pump 1 and pump 2 in sec. This time should be chosen so that the second pump only switches on after the first pump has shut down. To prevent a possible overloading of the mains supply due to the pumps’ starting currents, the second pumped is switched on after a short delay.

# Operating manual

## Basis pump control CPSB



**Nominal current of P1; nominal current of P2<sup>7</sup>:** This menu item allows you to set the nominal operating current of the pumps for electronic current monitoring. If the current exceeds the nominal value, the alarm is set off after a short time. If the measured current is less than half the nominal current, an undercurrent alarm is set off<sup>8</sup>. To ensure reliable operation, the value entered should be around 10% higher than the current displayed on the screen (under normal operating conditions). A value



If the pump, the values in this menu item should not be set. If the control unit is equipped with a motor circuit breaker for each.. Außer der Nennstrom der Pumpe ist kleiner als die geringste mögliche NennstromEinstellung des Motorschutzschalters. Dieses sollte nur bei Steuerungen erfolgen, bei denen sich die Pumpen im Nicht-ATEX-Bereich befinden. Andernfalls sollten die Motorschutzschalter an den Pumpennennstrom angepasst werden. The display then simply acts as a amperemeter.

**Exit menu:** Back to the Main Menu.

---

<sup>7</sup> only displayed if 2-pumps or 1/1-pumps is selected in menu item (#131)

<sup>8</sup> not in units with manual manual – zero – automatic switches

### 10.4 Sub-menu „Communication“

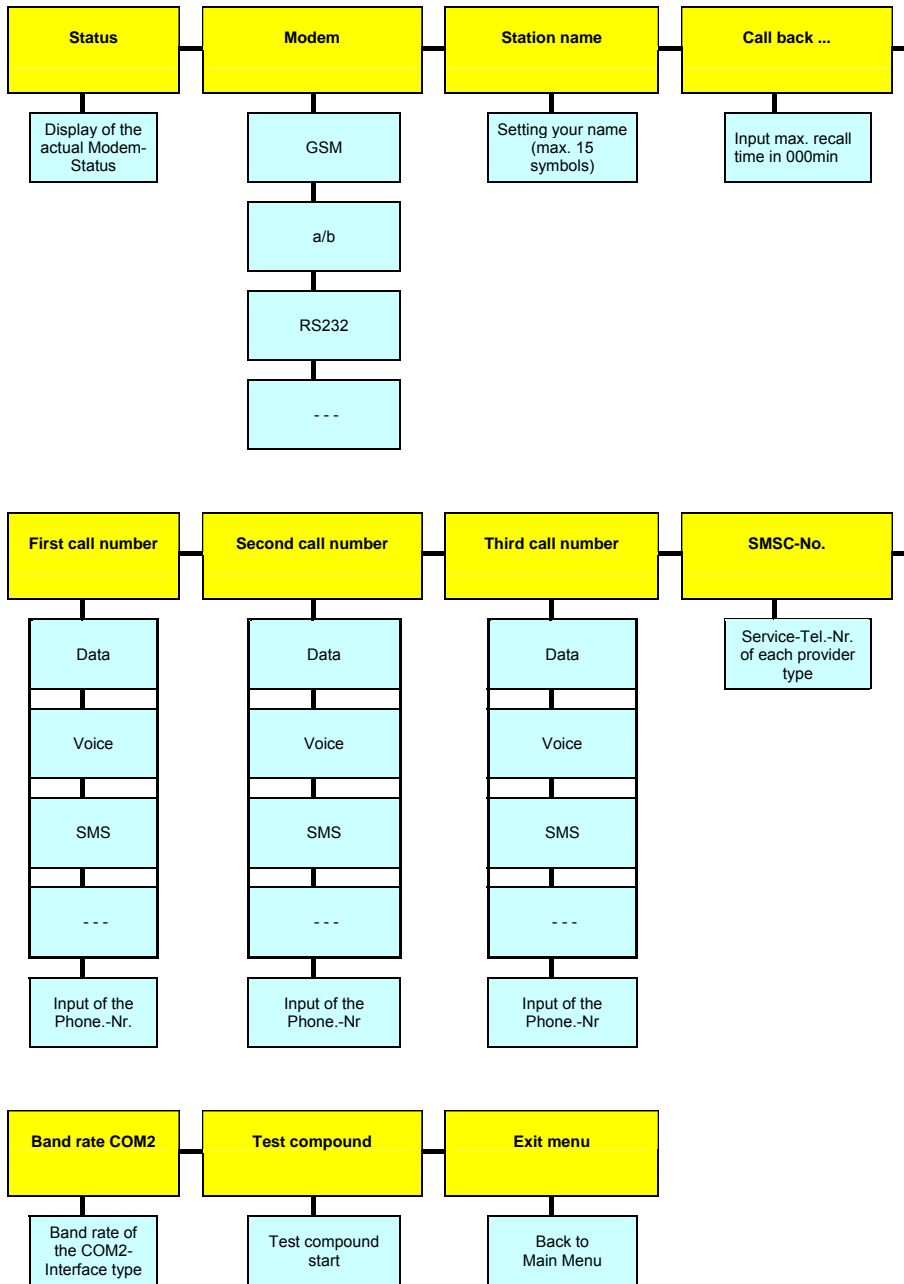

**Status display:** This menu item displays the current modem status.

**Modem:** This menu item allows you to choose, depending on the modem connected, between GSM, a/b, RS232 and ---- (no modem).

**Station name:** This menu item allows you to enter the relevant station name of the control unit. This station name is indicated in every message and serves to distinguish the different control units from each other. The station name may consist of up to 15 characters.

**Call-back after ...:** This menu item allows you to set the call-back time in min. When faults or an alarm occur, the first call number entered is rung. If there is no acknowledging call within the call-back time entered, the same call number is rung another two times. If after these two attempts there is still no return call (confirmation), the second call number entered is rung a maximum of 3 times, after which the third telephone number is rung a maximum of 3 times. If there is no return call to the maximum number of nine attempts, the control unit switches to "Now Answer" and there are no further attempts.  
You should not enter 000min. (undefined condition)

**1st telephone number; 2nd telephone number, 3rd telephone number:** In this menu item you can enter a maximum of three telephone numbers for the respective call recipients. In each menu you must first choose the desired form of data transfer from the following options: data (data exchange via the specialist communications software "Watertel"), voice (voice message), SMS (text message) and --- (no form of transmission). The call recipient's particular telephone number (15 characters max.) is then entered.

Entering the telephone number by GSM modems:

496789112233445  
1/ 2/ 3/

1. Country cod (without +)  
e.g. 49 for Germany
2. Area code for each call recipient (without 0),  
e.g. 6789
3. Telephone number of each call recipient,  
e.g. 112233445



**Warning: Do not enter any spaces,**  
e.g. 499876112233445

Entering the telephone number by a/b-Modem:

06789112233445  
1/ 2/

1. Area code for each call recipient  
e.g. für 06789
2. Telephone number of each call recipient  
e.g. 112233445



**Warning: Do not enter any spaces,**  
e.g. 06789112233445

**SMSC No.:** The SMSC No. of your provider is entered in this menu item (15 characters max.). The SMSC number is necessary to send a text message. Your provider can inform you of your valid SMSC No. A list with the most important SMSC Nos can be found in the section "SMSC Nos".

0189112233445  
1/ 2/

1. Area code for each SMSC-No.  
e.g. 0189
2. Telephone number of each SMSC-No.  
e.g. 112233445



**Warning: Do not enter any spaces,**  
e.g. 0189112233445)



# Operating manual

## Basis pump control CPSB



**Baud rate COM2:** This menu item allows you to choose the transmission speed of the COM2 interface. The following values are predetermined and can be changed according to the actual possible transmission speeds.

---	19 200	76 800
4 800	28 800	115 200
9 600	38 400	
1 4400	5 7600	

**Test connection:** When this menu item is selected, a test message with the current status of the control unit is sent to the first call number.

**Exit menu:** Back to the Main Menu.

### 10.5 Sub-menu „Alarms”

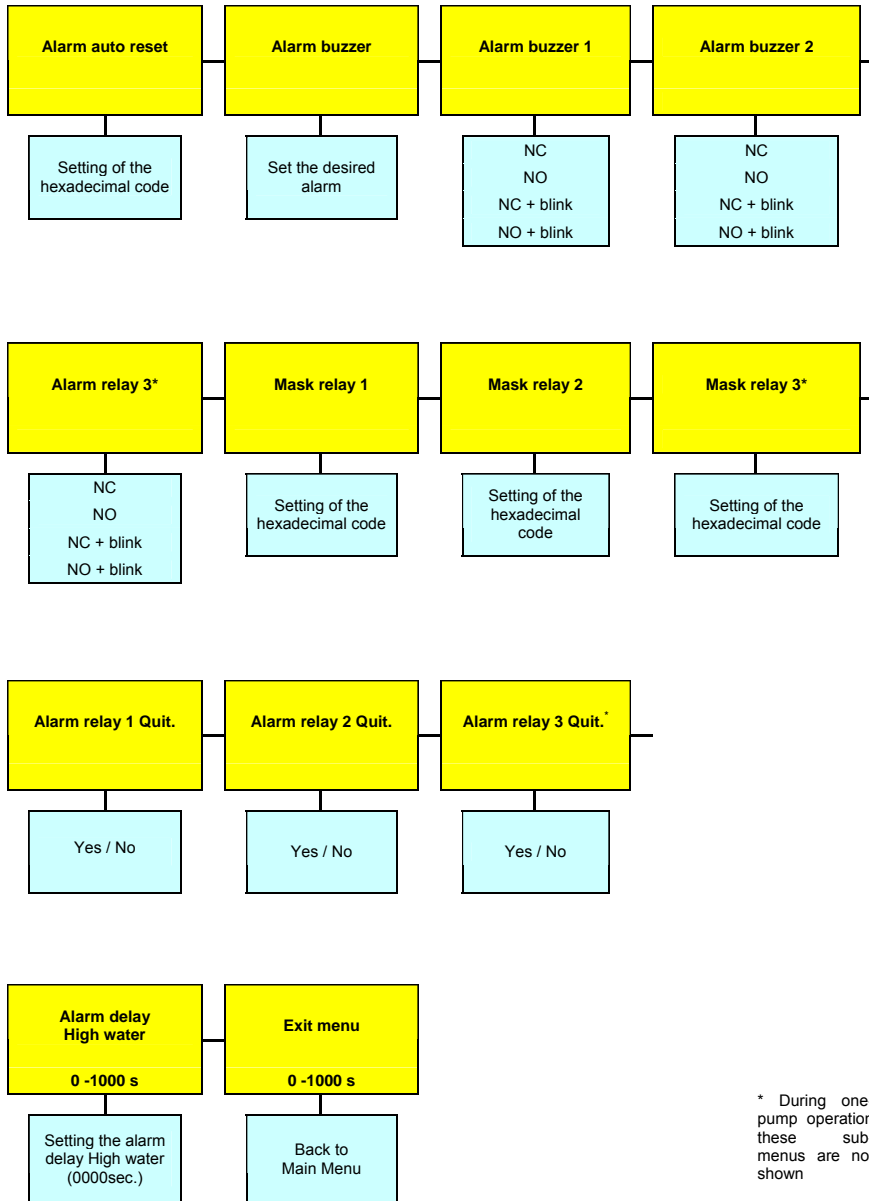

**Man. reset:** This menu item allows you to set which of the alarms can only be confirmed (reset) manually. If manual confirmation is not chosen for a particular alarm, it is immediately reset as soon as the alarm (fault) is no longer present. The relevant entry is made by means of a hexadecimal code for the chosen error message. Refer to section “Error code table” for information on how to convert the hexadecimal codes.

**Alarm sound:** This menu item allows you to choose the sound of the alarm.

# Operating manual

## Basis pump control CPSB



**Alarm relay 1<sup>9</sup>; alarm relay 2; alarm relay 3<sup>10</sup>**: These sub-menus allow you to choose the activation sequence of the alarm relays.

<b>NC</b>	Normally closed	Opens at alarm
<b>NO</b>	Normally open	Closes on Alarm
<b>NC blink</b>	Normally closed + flashing	Opens at alarm and flashing
<b>NO blink</b>	Normally open + flashing	Closes on Alarm and flashing

This function can be individually selected for each of the relays. This function is important to determine the behaviour if an alarm is triggered during a mains power failure.

**Relay mask 1; relay mask 2; relay mask 3<sup>11</sup>**: These sub-menus allow you to choose for each alarm relay with which alarm they should be activated. This makes it possible to freely assign the relay functions to the fault situations. This means that each relay can be assigned groups of faults. The appropriate entry is made by means of a hexadecimal code for the chosen error message. Refer to section "Error code table" for information on how to convert the hexadecimal codes.

**Permitted T1 alarms** If during operation, a T1 alarm is triggered frequently (by thermal contact T1), for example due to overloading, this menu item allows you to prevent the control unit from not restarting again automatically after an adjustable number of alarms, once the pump has cooled down, since it can be assumed that there is a systematic error. The maximum number of times the T1 thermal contact is triggered can be set here. If the T1 fault has occurred more frequently since the last time the alarms were confirmed than the value entered here, the control unit will stop and "nxT1" will appear on the display. If this mode is not used, this value should be set to 0.

**High water alarm delay:** This sub-menu allows you to set the time in sec that must elapse before the High water alarm is triggered after the High water level has been exceeded or after activation of the High water float. This means that short-term High water levels do not lead to an alarm being triggered. However, the display does show the message "(HW)" immediately. The delay period is evident due to the flashing red LED. If the time is exceeded the LED stops flashing and stays red continuously, "HW" is displayed and the alarm buzzer sounds.

**Exit menu:** Back to the Main Menu.

---

<sup>9</sup> if compressor or agitator was chosen as a factory setting, alarm relay 1 has a different function (see section: Sub-menu compressor or agitator (#192))

<sup>10</sup> in one-pump operation these sub-menu items are not shown

<sup>11</sup> in one-pump operation these sub-menu items are not shown

### 10.6 Sub-menu „Basic settings”

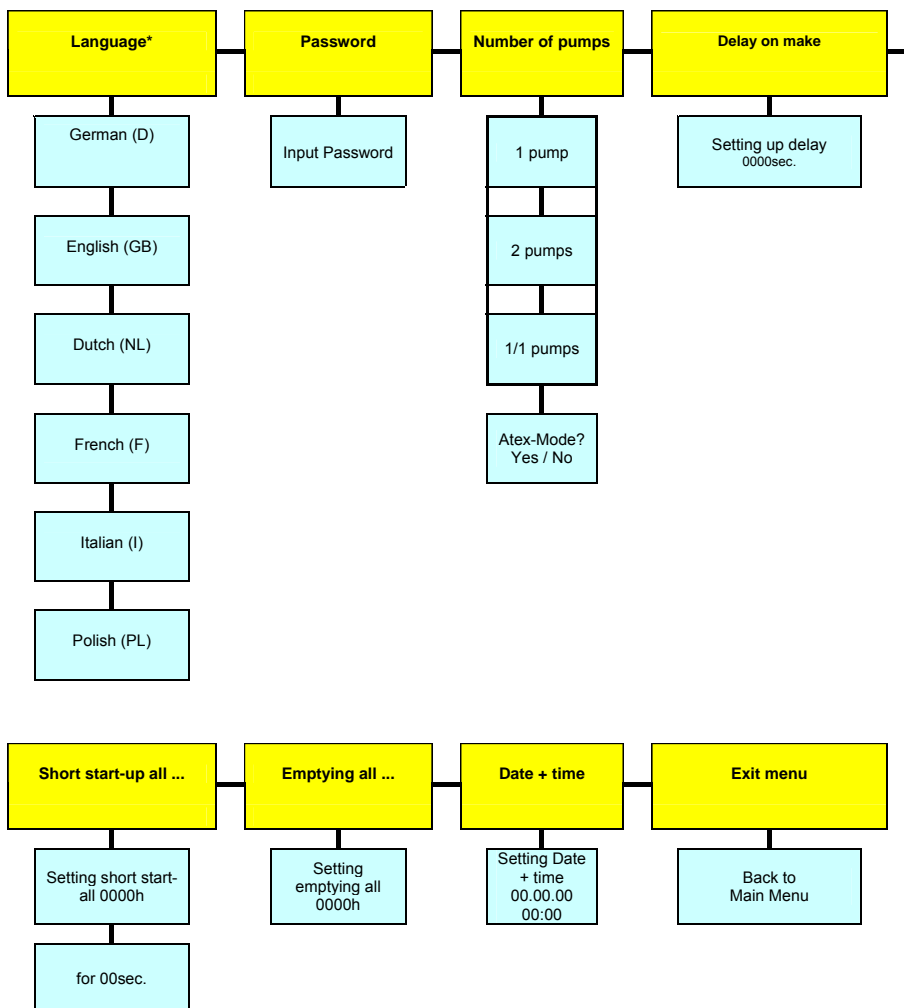

\* possibly other languages on request

**Language:** This sub-menu allows you to choose the language of the user interface. All text is displayed in the chosen language.

**Password:** This sub-menu allows you to change the password of the control unit<sup>12</sup>. The password should be noted in a safe area, since without it access to the system menu of the control unit is no longer possible.



**If the password is lost, the control unit must be reconfigured by the factory, since for safety reasons no changes to the setting can be made without the password.**

**Number of pumps<sup>13</sup>:** This sub-menu allows you to determine whether the control unit works as a one- or two-pump control unit.

- **1** - one pump
- **2** - peak load operation two pumps
- **1/1** - alternating operation of two pumps (load alternating mode – only one pump is ever running)

<sup>12</sup> the password is set to 0000 by the factory.

<sup>13</sup> only displayed, if the factory setting is set to two-pump control. With one-pump control units Atex mode can be selected in the sub-menu item #131

# Operating manual

## Basis pump control CPSB



**Start-up delay:** In this sub-menu the start-up delay of the control unit can be set in sec. After switching on the control unit, the unit does not start up immediately, but is only activated after the time entered here. Even after a mains or phase error, the control unit is only (re)activated after this time has passed. A value of 0000sec. switches off this function. If the value is set to 1000sec., the time for each start-up is chosen randomly (between 0 and 59sec). After a power failure affecting many control units, this setting can prevent all the control units from switching on at the same time (current peak).

**Quick start every ...:** Pumps that are not in operation for a long time, may require starting at regular intervals. This sub-menu allows you to set a compulsory start-up of the pumps. The quick start allows you to start the pumps every h for a few sec. If the pumps have been inactive for the time entered, they will be activated after the time has elapsed for the number of seconds entered. If a pump is normally operated via the level control unit, the quick start timer begins counting again from (0000h).

The following table shows an example of the activation sequence during a quick start:

Short start-up		Stop level of the respective pump	Switching behavior of the respective pump
all 024h	for 10sec.	below	Pump in operation for 10 seconds every 24 hours
		not below	Pump every 24 hours in operation, was to undercut each stop level.

**Empty pumps every ...:** In the case of installations that are only used infrequently, the activation level may not be reached for relatively long periods of time. However, it may be undesirable for the wastewater to remain in the shaft for this length of time. This sub-menu allows you to set a time in h. If after the time set (depending on the last pumping cycle), the activation level has not been reached, the shaft will be pumped off until the relevant deactivation level has been reached. A value of 0000h. switches off this function.



**For installations with the “open immersion bell” level system with no air bubbling system, releasing the immersion bell is only possible if the run-on time is specified.**

**Date + Time:** This menu item allows you to set the current date and current time.

00.00.00    00:00  
 1/                    2/

1. Enter the date as day, month, year
2. Enter the time as hours, minutes

Date and time are not needed for normal operation of the control unit. They are only used to save faults with a time and date, thus enabling a more accurate fault analysis. The clock is monitored by the software. If the clock battery is empty, faulty or not inserted, a CLOCK fault is identified, if the control unit was switched off for a while and the clock was without power supply. This error is also shown if the clock has not been set at least once after installation of a new battery. The clock on a newly delivered CPS must therefore be set to remove the CLOCK error message.

**Exit menu:** Back to the Main Menu.

### 10.7 Sub-menu „Timer“

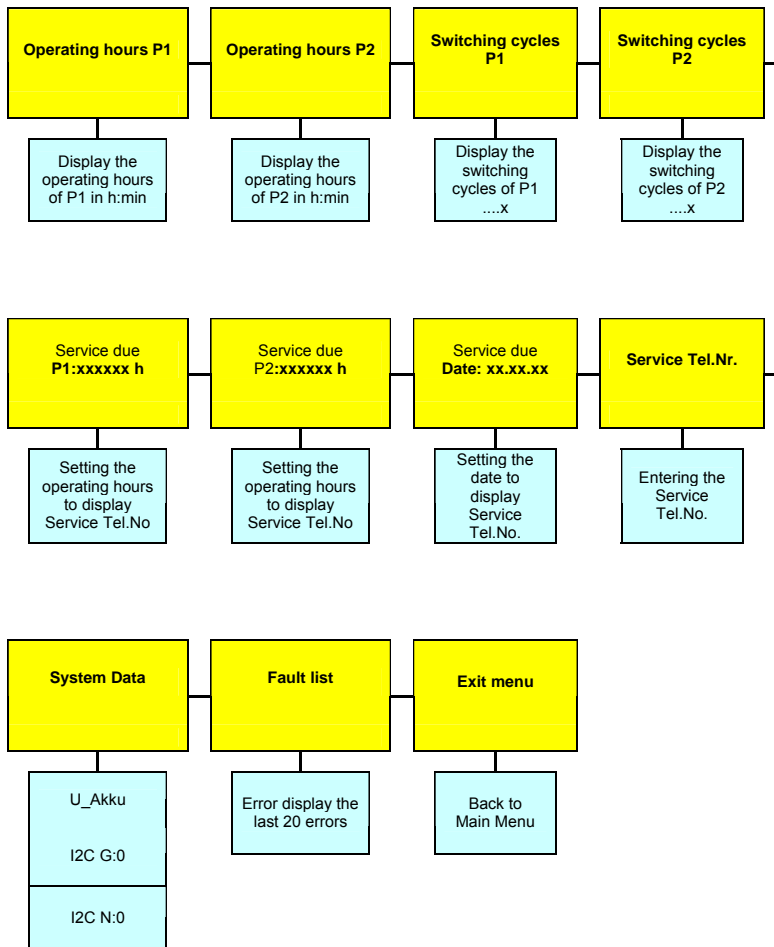

**Operating hours of P1; operating hours of P2; switching cycle of P1; switching cycle of P2:** These sub-menus display the data concerning the operating hours and switching cycles of the individual pumps. It is not possible to enter information into these sub-menus.

**Service due P1; service due P2<sup>14</sup>; service due date; service tel. No.:** This menu item allows you to activate a service message. It is possible to determine at what time a manually entered service tel. No. should be automatically displayed on the screen and an internal buzzer activated. They will be activated as soon as the first condition is fulfilled, meaning either the operation hours entered or the date entered has been reached. Pressing the key “alarm off”  resets the internal acoustic alarm. The cyclical display of the tel. No. can only be reset by entering the new number of operating hours and the new servicing date during servicing.

<sup>14</sup> During one-pump operation these sub-menu items are not displayed

# Operating manual



## Basis pump control CPSB

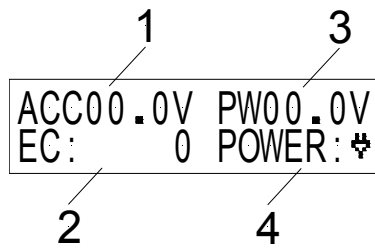

**System data:** This sub-menu displays the current system data of the control unit. It is not possible to enter information into this sub-menu.



1. Battery voltage
2. EC
3. Control voltage
4. Network type.:

Mains operation   
 or Battery operatio 

**Fault list:** This menu item contains the last 20 saved faults. It is not possible to enter information into this sub-menu.

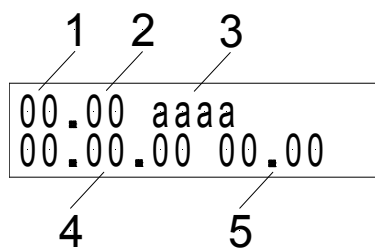

1. Serial number
2. Error code
3. Error definition
4. Date of the error
5. Time of the error

The exact description of the faults can be found in the fault list (see separate chapter).

**Exit menu:** Back to the Main Menu.

### 10.8 Sub-menu “Compressor or agitator”<sup>15</sup>:



If the compressor or agitator function is used, alarm relay 1 is no longer available, nor is the external alarm input. The compressor or agitator is then connected to alarm relay 1.

If the compressor or agitator is switched to "always off", alarm relay 1 operates as normal. Note: This means that no compressor or agitator should be connected to the relay. In order to switch off a connected compressor or agitator when necessary, the operating mode should be set to "switch OFF" and the running time to "000sec.". Please note that faults that were reported via alarm relay 1 are no longer active. Alarm relays 2 and 3 must be used for this purpose. The alarm settings must be adjusted accordingly.

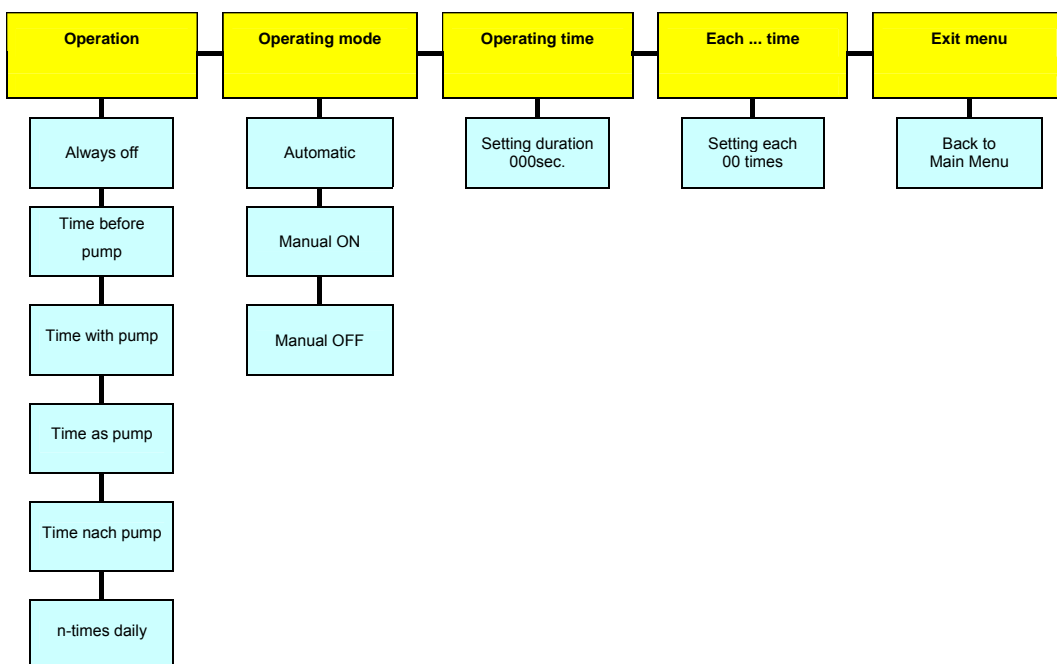

**Function:** This sub-menu allows you to determine how the compressor or agitator operates.

- **Always off:** The compressor or agitator is deactivated and will not be activated automatically. The control unit will operate like a standard control unit. Even manual activation of the agitator is not possible. Alarm relay 1 can therefore be used as an alarm relay.
- **Time before pump:** The agitator is activated once the activation level has been reached before the pumps start and will run for the time set. Once this time has elapsed the pump(s) start.
- **Time with pump:** The agitator starts with the pump(s) and runs for the set running time.
- **Time as pump:** The agitator starts with the pump(s) and runs for the same length of time as the pump(s).
- **N-times per day:** The compressor or agitator starts n-times per day and runs for the set running time.

<sup>15</sup> Only shown if compressor or agitator has been selected in the factory settings.



# Operating manual

## Basis pump control CPSB



**Running time:** This menu item sets allows you to set the running time of the compressor or agitator up to a maximum of “000-999 sec.”.

**every ... time:** This sub-menu allows you to set how often the compressor or agitator should start in the form of the “00 time”. If, for example, 03 time is chosen, two pump cycles are run without the compressor or agitator; the compressor or agitator only starts up on the third pump cycle. If a value of “00 time” or “01 time” is chosen in this menu, the compressor or agitator operates during every pumping cycle.

**Important:** After the settings have been changed or after a complete loss of the power supply, the first pumping cycle is not counted in order to restore the counting rhythm.

**A 00:00 time:** In this sub-menu the switching on time of the compressor or agitator is entered. At this time relay 1 would switch over for as long as determined by the entered running time.

**CAUTION:** If the compressor or agitator cannot run at the same time as the pump(s), this must be configured in the hardware. This cannot be prevented by software.

**IMPORTANT:** If the control unit is operated without a 12V battery and there is a loss of power, then the integrated clock also stops for the period the power is lost. This means that once the power returns the clock runs late and the switching on time for the compressor / agitator has shifted.

**Exit menu:** Back to the Main Menu.

### 11 System menu / parameter settings for a control unit with a graph. display

#### 11.1 Overview Main Menu

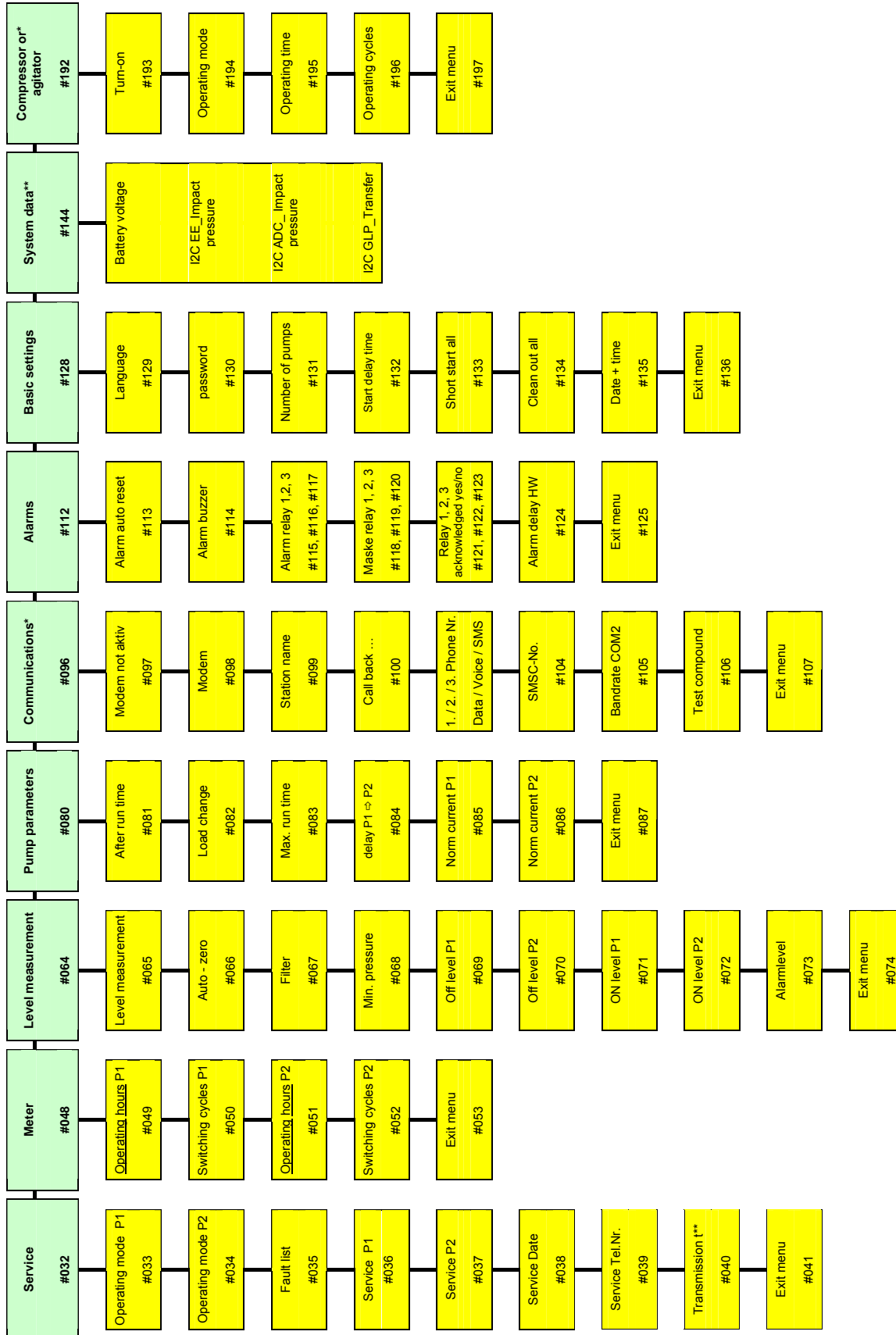

\* Only for release

\*\* Only for release

### 11.2 Sub-menu „Service“ (#032)

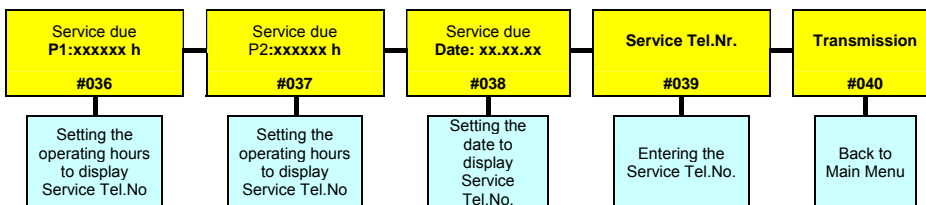
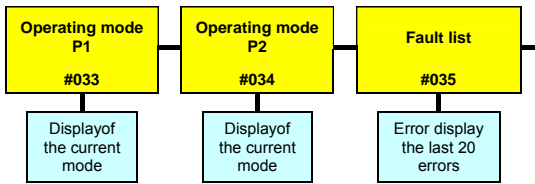

**Operating mode P1 (#033); operating mode P2 (#034):** This menu item displays the **P1 Operating mode (#033); P2 operating mode: (#034):** This menu item sets the operating mode of pump 1 or pump 2. The selected mode of operation is displayed in this menu as well as in the main display (including its activation state).

**Automatic:** The pumps are switched ON or OFF automatically depending on the level set.

**Manual ON:** The pumps remain in operation until they are switched off by hand. If Atex mode has been selected, the pumps remain in operation until the lower deactivation level is reached.



**If the operating mode “STD” standard and not ATEX is selected, the pumps run as long as they are manually switched on. The operator is responsible for preventing the pumps running dry.**

**Manual OFF:** The pumps are switched off. Even if a change in the level sends a signal to the pumps, the pumps remain switched off.

**Fault list (#035):** This menu item displays the last twenty saved faults. It is not possible to enter information in this menu item.

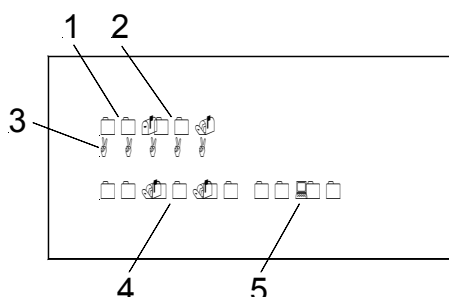

1. Serial number
2. Error code
3. Error definition
4. Date of the error
5. Time of the error

Exact fault descriptions can be found in the fault list (see separate chapter).

**Service due P1 (#036); service due P2<sup>16</sup> (#037); service due date (#038); service tel. No. (#039):** This menu item allows you to activate a service message. It is possible to determine when a manually entered service tel. No. should be automatically displayed on the screen and an internal buzzer should be activated. They will be activated as soon as the first condition is fulfilled, meaning either the operating hours entered or the date entered has been reached. Pressing the key “alarm off” resets the internal acoustic alarm. The cyclical display of the tel. No. can only be reset by entering the new number of operating hours and the new servicing date during servicing.

**Transfer mode (#040)<sup>17</sup>:** This menu item displays the optional remote data transmission settings. It is not possible to enter information here.

**Exit menu (#041):** Back to the Main Menu.

### 11.3 Sub-menu „Timer“ (#048)

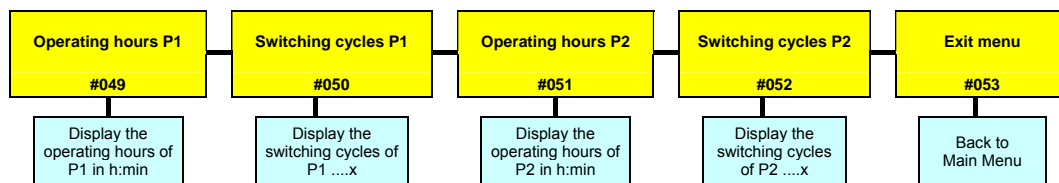

In diesem Untermenü werden die entsprechenden Daten in Bezug auf Betriebsstunden und Schaltzyklen der einzelnen Pumpen angezeigt.

### 11.4 Sub-menu „Level measurement method“ (#064)

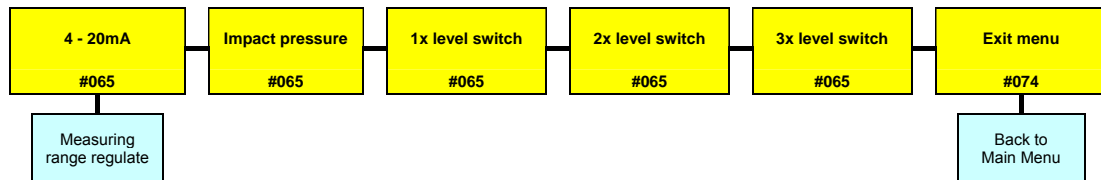

**Select measuring system (#065):** This menu item allows you to choose the measuring system used.

- Level measurement: 4... 20mA Interface over Level sensor
- Impact pressure (measuring range 0 ... 200cm WS)
- 1x float switch
- 2x float switch
- 3x float switch (only in two-pump operation possible)

If a 4-20mA (Level sensor) measuring system is selected, it is necessary to enter the measurement range of the connected sensor after selecting the measuring system.

<sup>16</sup> During one-pump operation these sub-menu items are not displayed

<sup>17</sup> Is only displayed if a modem is selected (#098).

**The following sub-menus are only activated if the "4-20mA" and "dynamic pressure" measuring systems are selected:**

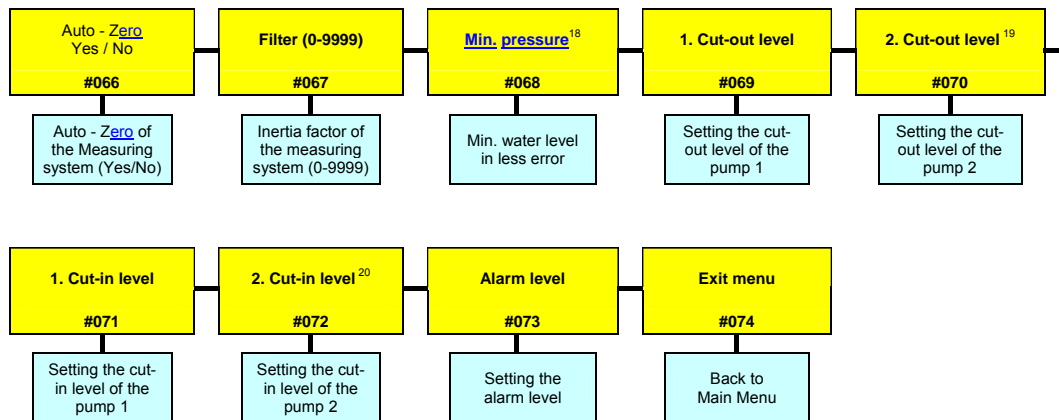

**Zero balancing (#066):** This menu item allows you to carry out a zero balancing adjustment of the measuring system in operation. The measuring system must not be in the water during adjustment. It is also necessary to ensure that the measuring system remains inoperative during the balancing procedure. Zero balancing can be repeated at any time.

**Filter (#067):** When water levels are unstable, the level display may also be unstable. A low-pass filter helps to stabilise the display and causes the level measuring system to react more slowly.

0000" = filter OFF, "0001" = weak (rapid) filter ... "9999" strong (slow) filter



**Warning:** If the filter is activated, the level display may become so sluggish that the measured level differs significantly from the actual level in the shaft. The shaft may already be empty whereas the measured value shows a level above the deactivation level, meaning the pump could run dry. Pump performance, activation levels and filter values therefore have to be carefully adjusted in relation to each other.

**Not necessary for normal use**

**Minimum pressure (#068)<sup>21</sup>:**

This menu item allows you to set a minimum pressure for the measuring system in cm. This set value can be monitored by the control unit. If the level measurement falls below the pressure set here, a fault message is issued. If the value "0000cm" is set, the minimum pressure monitoring system is switched off. This function can also be used if the level should not sink below a certain minimum level or if air bubbles from a small compressor need to be monitored.

<sup>18</sup> only displayed if "dynamic pressure" measuring system has been selected.

<sup>19</sup> only displayed if 2 pump mode has been selected in menu item (#131)

<sup>20</sup> only displayed if 2 pump mode has been selected in menu item (#131)

<sup>21</sup> only displayed if "dynamic pressure" measuring system has been selected.

**1st deactivation level(#069); 2nd deactivation level (#070)**<sup>22</sup>: This menu item allows you to set the respective deactivation levels of the pumps in cm. The values must be adjusted to the specific local conditions.



**Warning:** The deactivation levels must be lower than the activation levels (“OFF” < “ON”). The control unit automatically checks these values against the activation levels. If the levels are incorrect, the "level measurement" sub-menu displays a "?" and the values entered need to be corrected.

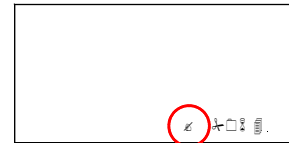

**1st activation level (#071); 2nd activation level (#072)**<sup>23</sup>: This menu item allows you to set the respective activation levels of the pump in cm. The values must be adjusted to the specific local conditions.

**Alarm level (#073)::** This menu item allows you to set the alarm level. The values need to be adjusted to the specific local conditions.

**Exit menu (#074) :** Back to the Main Menu.

### 11.5 Sub.menu „Pump data” (#080)

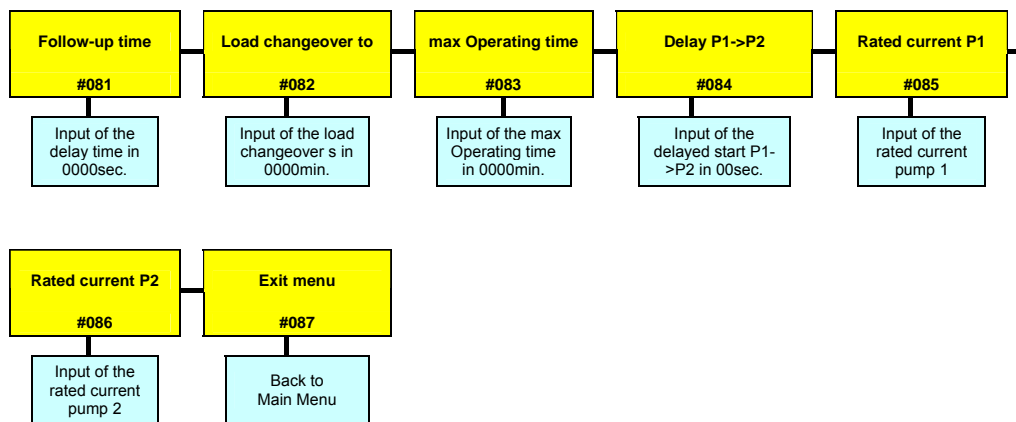

**Run-on time (#081):** This menu item allows you to set the run-on time of the pumps in sec. This is the time the pumps will continue to operate after the deactivation level has been reached. The setting range can be freely adjusted between “000 – 9999sec”. A value of “0000sec.” switches off this function.



**If the run-on time is too long, the pumps may run dry and suffer damage as a result.**

<sup>22</sup> only displayed if 2 pump mode has been selected in menu item (#131)

<sup>23</sup> only displayed if 2 pump mode has been selected in menu item (#131)

**Load alternation after ... (#082):** This menu item allows you to set the load alternation behaviour of the control unit in minutes. If a value of "0000min." is set, the load alternation is only carried out after both pumps have been switched off. If a value between "0001 and 9998min." is chosen, load alternation occurs after both pumps are deactivated, but at the latest after the time set here. A value of "9999min." switches off the load alternation function, meaning the control unit generally starts with pump 1 and pump 2 is always the peak load pump.



**Warning:** If, in menu item #131, operating mode 1/1 is selected, a value of "9999min." means that pump 2 never switches on automatically.

**Max. running time (#083):** This menu item allows you to limit the max. running time of the pump(s) to a time between "000-999min." If the pump(s) is(are) activated continuously for longer than the time set here, it(they) will be switched off and an alarm will sound. If, in a two-pump control unit, one pump is activated, the control unit switches to the other pump once this time has elapsed and an alarm is set off. When the pump that was switched on also reaches the running time limit, it is also switched off and a further alarm is sounded. A value of "0000min." switches off this function.

**P1->P2 delay (#084):** This menu item allows you to set the delay time between pump 2 and pump 1 in sec. This time should be chosen so that the second pump only switches on after the first pump has shut down. The second pumped is switched on after a short delay to prevent a possible overloading of the mains supply due to the pumps' starting currents.

**Nominal current of P1 (#085); nominal current of P2 (#086) <sup>24</sup>:** This menu item allows you to set the nominal operating current of the pump for the electronic current control unit. If the current exceeds the nominal value, the alarm is set off after a short time. If the measured current is less than half of the nominal current, an undercurrent alarm is set off<sup>25</sup>. To ensure reliable operation, the value entered should be around 10% higher than the current displayed on the screen (under normal operating conditions). A value of 00.0A switches current monitoring off.



If the control unit is equipped with a motor circuit breaker for each pump, the values in this menu item should not be set. Außer der Nennstrom der Pumpe ist kleiner als die geringste mögliche Nennstromeinstellung des Motorschutzschalters. Dieses sollte nur bei Steuerungen erfolgen, bei denen sich die Pumpen im Nicht-ATEX-Bereich befinden. Andernfalls sollten die Motorschutzschalter an den Pumpennennstrom angepasst werden. The display then simply acts as a amperemeter.

**Exit menu (#087):** Back to the Main Menu.

<sup>24</sup> only displayed if 2 pumps or 1/1 pumps has been selected in menu item (#131)

<sup>25</sup> not in control units with manual manual-0-automatic switches

### 11.6 Sub-menu „Communication“ (#096)

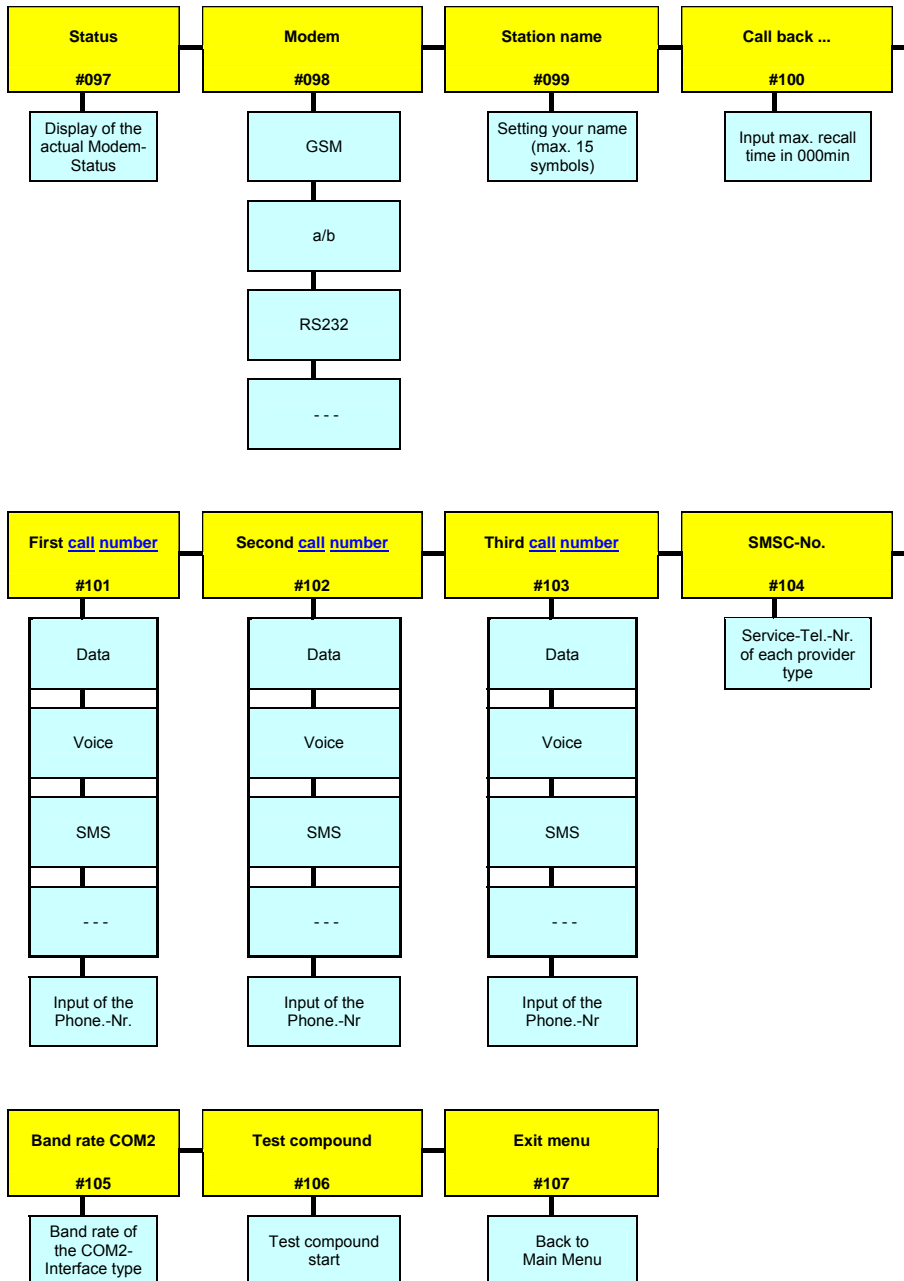

#### Status display (#097):

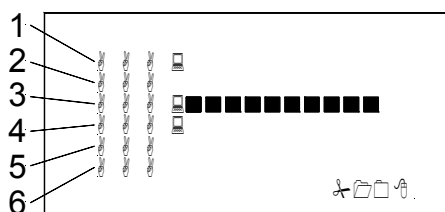

1. Modem type
2. Indication of the provider
3. Signal strength
4. Modem status
5. Current function of the modem
6. Current reviews of the modem



# Operating manual

## Basis pump control CPSB



**Modem (#098):** This menu item allows you to choose, depending on the modem connected, between GSM, a/b, RS232 and --- (no modem).

**Station name (#099):** This menu item allows you to enter the relevant station name of the control unit. This station name is indicated in every message and serves to distinguish the different control units from each other. The station name may consist of up to 15 characters.

**Call-back after ... (#100):** This menu item allows you to set the call-back time in min. When faults or an alarm occur, the first call number entered is rung. If there is no acknowledging call within the call-back time entered, the same call number is rung another two times. If after these two attempts there is still no return call (confirmation), the second call number entered is rung a maximum of 3 times, after which the third telephone number is rung a maximum of 3 times. If there is no return call to the maximum number of nine attempts, the control unit switches to "Now Answer" and there are no further attempts.  
You should not enter 000min. (undefined condition)

**1st telephone (#101); 2nd telephone (#102); 3rd telephone number:** In this menu item you can enter a maximum of three telephone numbers for the respective call recipients. In each menu you must first choose the desired form of data transfer from the following options: data (data exchange via the specialist communications software "Watertel"), voice (voice message), SMS (text message) and --- (no form of transmission). The call recipient's particular telephone number (15 characters max.) is then entered.

Entering the telephone number by GSM modems:

496789112233445  
1/      2/                      3/

4. Country cod (without +)  
e.g. 49 for Germany
5. Area code for each call recipient (without 0),  
e.g. 6789
6. Telephone number of each call recipient,  
e.g. 112233445



**Warning:** Do not enter any spaces,  
e.g. 499876112233445

# Operating manual

## Basis pump control CPSB



**SMSC No.:** The SMSC No. of your provider is entered in this menu item (15 characters max.). The SMSC number is necessary to send a text message. Your provider can inform you of your valid SMSC No. A list with the most important SMSC Nos can be found in the section "SMSC Nos".

0189112233445

1/ 2/

3. Area code for each SMSC-No.  
e.g. 0189
4. Telephone number of each SMSC-No.  
e.g. 112233445



**Warning:** Do not enter any spaces,  
e.g. 0189112233445)

**Baud rate COM2 (#105):** This menu item allows you to choose the transmission speed of the COM2 interface. The following values are predetermined and can be changed according to the actual possible transmission speeds.

---	19 200	76 800
4 800	28 800	115 200
9 600	38 400	
14 400	57 600	

**Test connection (#106):** When this menu item is selected, a test message with the current status of the control unit is sent to the first call number

**Exit menu (#107):** Back to the Main Menu.

### 11.7 Sub-menu „Alarms“ (#112)

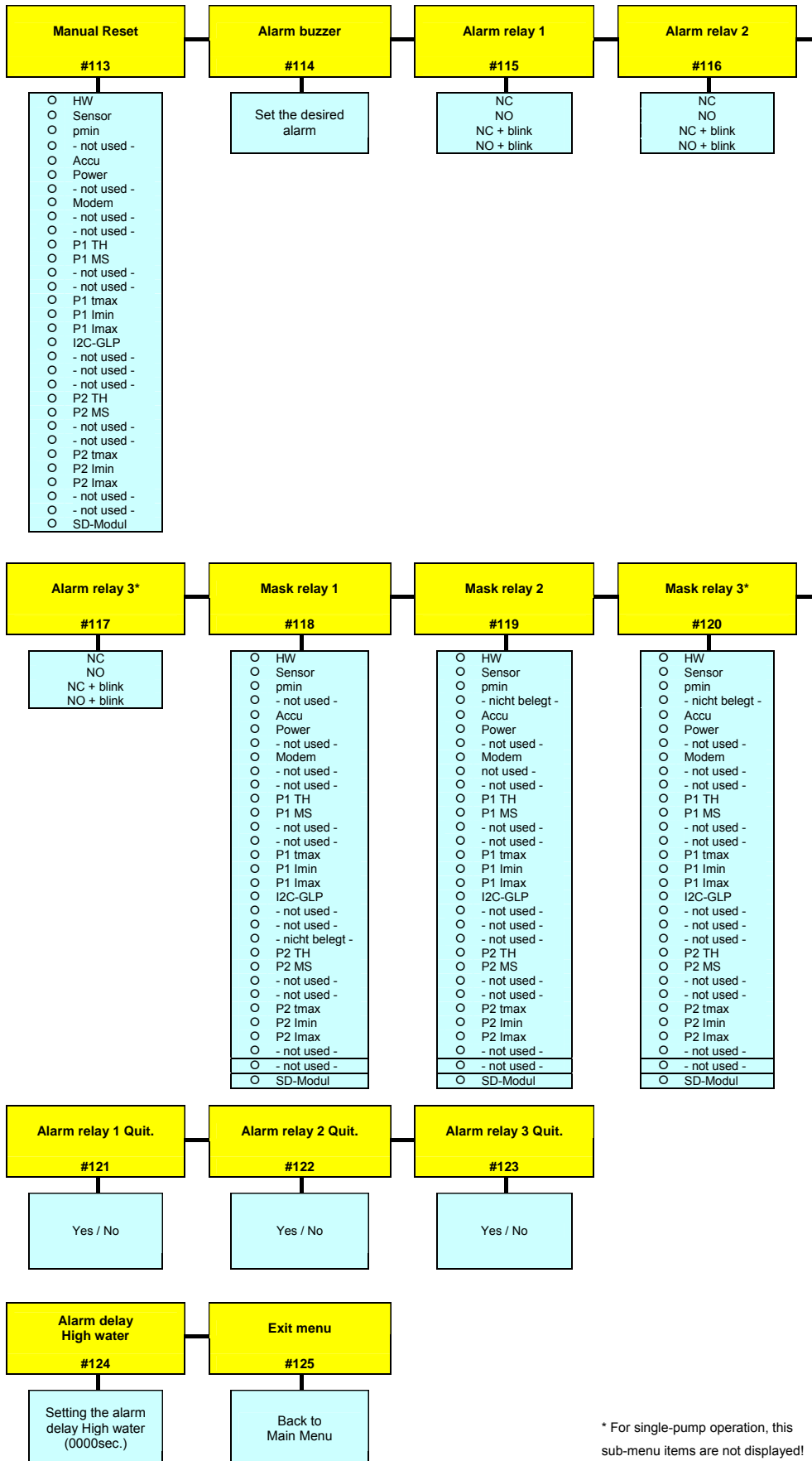

\* For single-pump operation, this sub-menu items are not displayed!

# Operating manual

## Basis pump control CPSB



**Man. reset (#113):** This menu item allows you to set which alarm messages need to be manually confirmed (reset). To do this the key “reset”  must be pressed. If an alarm isn't set to manual confirmation, it will be automatically reset as soon as the alarm (fault) is no longer present.

**Alarm sound (#114):** This point on the menu allows you to choose the preferred alarm sound and also switch the alarm buzzer on or off.

**Alarm relay 1 (#115)<sup>26</sup>; alarm relay 2 (#116); alarm relay 3(#117)<sup>27</sup>:** These sub-menus allow you to choose the activation settings of alarm relays.

<b>NC</b>	Normally closed	Opens at alarm
<b>NO</b>	Normally open	Closes on Alarm
<b>NC blink</b>	Normally closed + flashing	Opens at alarm and flashing
<b>NO blink</b>	Normally open + flashing	Closes on Alarm and flashing

This function can be chosen individually for each of the relays. This function is important to determine the behaviour if an alarm is triggered during a mains power failure.

**Relay mask 1 (#118); relay mask 2(#119); relay mask 3(#120)<sup>28</sup>:** These sub-menus allow you to choose for each alarm relay with which alarm they are meant to activate. You can therefore freely assign the relay functions to the fault situations. This means that each relay can be assigned groups of faults. The appropriate entry is made by means of a hexadecimal code for the chosen error message. Refer to section “Error code table” for information on how to convert the hexadecimal codes.

**Relay 1 confirm. (#121)<sup>29</sup>; relay 2 confirm. (#122), relay 3 confirm (#123)<sup>30</sup>:** In these sub-menus the reset function of the relays can be set. If the relay is set to confirm “yes”, then the relay switches over in response to the fault and after quickly pressing the "alarm off" key the relay switches back. This can be used to deactivate external alarm equipment (horn, warning light), which are connected via the relay. If the relay is set to confirm “No”, then the relay switches over in response to a fault and only switches back after the fault has been removed and confirmed.

**High water alarm delay (#124):** This sub-menu allows you to set the time in sec. that must elapse after the High water level is exceeded or after activation of the High water float, before the High water alarm is triggered. This means that short-term High water levels do not lead to an alarm being triggered. However, the display does show the message “(HW)” immediately. The delay period is evident due to the flashing red LED. If the time is exceeded, the LED is continuously lit, "HW" is displayed and the alarm buzzer sounds.

**Exit menu (#123):** Back to the Main Menu.

<sup>26</sup> if compressor or agitator has been selected in the factory settings, alarm relay 1 has a different function (see section: Compressor or agitator sub-meni (#192))

<sup>27</sup> in one-pump operation these sub-menu items are not shown

<sup>28</sup> in one-pump operation these sub-menu items are not shown

<sup>29</sup> If compressor or agitator is set in the factory menu (factory settings), alarm relay 1 has a different function (see section: “Compressor or agitator sub-menu (#192))

<sup>30</sup> During one-pump operation these sub-menu items are not displayed

### 11.8 Sub-menu „Basic settings“ (#128)

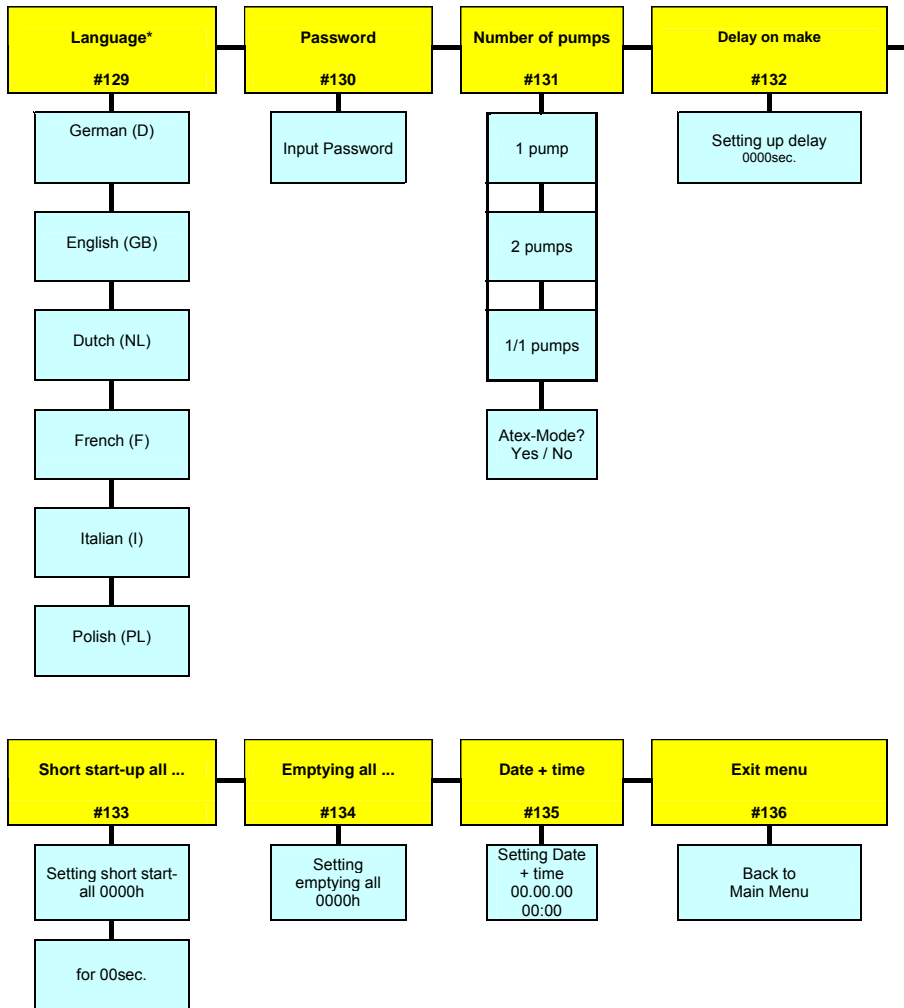

\* possibly other languages on request

**Language (#129):** This sub-menu allows you to choose the language of the user interface. All text is displayed in the chosen language.

**Password (#130):** This sub-menu allows you to change the password of the control unit<sup>31</sup>. The password should be noted in a safe area, since without it access to the system menu of the control unit is no longer possible.



**If the password is lost, the control unit must be reconfigured by the factory, since for safety reasons no changes to the settings can be made without the password.**

<sup>31</sup> the standard password set by the factory is 0000.

# Operating manual

## Basis pump control CPSB



**Number of pumps (#131)**<sup>32</sup>: This sub-menu allows you to determine whether the control unit works as a one- or two-pump control unit.

- **1** - one pump
- **2** - peak load operation two pumps
- **1/1** - alternating operation of two pumps (load alternating mode – only one pump is ever running)

**Start-up delay (#132)**: In this sub-menu the start-up delay of the control unit can be set in sec. After the control unit is switched on, it waits the stipulated time before actually starting up. Even after a mains or phase error, the control unit is only (re)activated after this time has passed. A value of 0000sec. switches off this function. If the value is set to 1000sec., the time for each start-up is chosen randomly (between 0 and 59sec). After a power failure affecting many control units, this setting can prevent all the control units from switching on at the same time (current peak).

**Quick start every ... (#133)**: If the pumps remain inactive for a long time, it may be necessary to start the pumps at regular intervals. This sub-menu allows you to select a compulsory start-up of the pumps. The quick start allows you to start the pumps every h for a few sec. If the pumps have been inactive for the time set, they will be activated after the time has elapsed for the number of seconds entered. If a pump runs normally via the level control unit, the quick start timer begins counting again from (0000h).

The following table shows an example of the pumps' activation sequence during a quick start:

Short start-up		Stop level of the respective pump	Switching behavior of the respective pump
all 024h	for 10sec.	below	Pump in operation for 10 seconds every 24 hours
		not below	Pump every 24 hours in operation, was to undercut each stop level.

**Empty pumps every ... (#134)**: In the case of installations that are rarely used, the activation level may not be reached for relatively long periods of time. It may nevertheless be undesirable for the sewage to remain in the shaft for a long time. This sub-menu allows you to set a time in h. If after the time set (depending on the last pumping cycle), the activation level hasn't been reached, the shaft will be pumped off until the relevant deactivation level has been reached. A value of 0000h. switches off this function.



**For installations with the open immersion bell level system with no air bubbling system, releasing the immersion bell is only possible if the run-on time is specified.**

<sup>32</sup> only displayed if the factory setting is set to two-pump control. With one-pump control units, Atex mode can be chosen in sub-menu item #131

**Date + Time (#135):** This menu item allows you to set the current date and current time.

00.00.00 00:00  
1/ 2/

3. Enter the date as day, month, year
4. Enter the time as hours, minutes

Date and time are not needed for normal operation of the control unit. They are only be used to save faults with a time and date, thus enabling a more accurate fault analysis. The clock is monitored by the software. If the clock battery is empty, faulty or not inserted, a CLOCK fault is identified, if the control unit was switched off for a while and the clock was without power supply. This error is also shown if the clock has not been set at least once after installation of a new battery. The clock on a newly delivered CPS must therefore be set to remove the CLOCK error message.

**Exit menu (#136):** Back to the Main Menu.

### 11.9 Sub-menu „System data“ (#144)

This sub-menu displays the current system data of the control unit. It is not possible to enter information into this sub-menu.

Akkuspannung:	14.1V	1	Battery voltage
I2C EE_Staudruck:	00	2	Error pressure modul
I2C ADC_Staudruck:	00	3	Error AD-Convertor
I2C GLP_Transfer:	00	4	Error GLP-Transfer

### 11.10 Sub-menu “Compressor or agitator”(#192)<sup>33</sup>



If the compressor or agitator function is used, alarm relay 1 is no longer available, nor is the external alarm input. The compressor or agitator is then connected to alarm relay 1.

If the compressor or agitator is switched to "always off", alarm relay 1 operates as normal. Note: This means that no compressor or agitator should be connected to the relay. In order to switch off a connected compressor or agitator when necessary, the operating mode should be set to "switch OFF" and the running time to "000sec.". Please note that faults that were reported via alarm relay 1 are no longer active. Alarm relays 2 and 3 must be used for this purpose. The alarm settings must be adjusted accordingly.

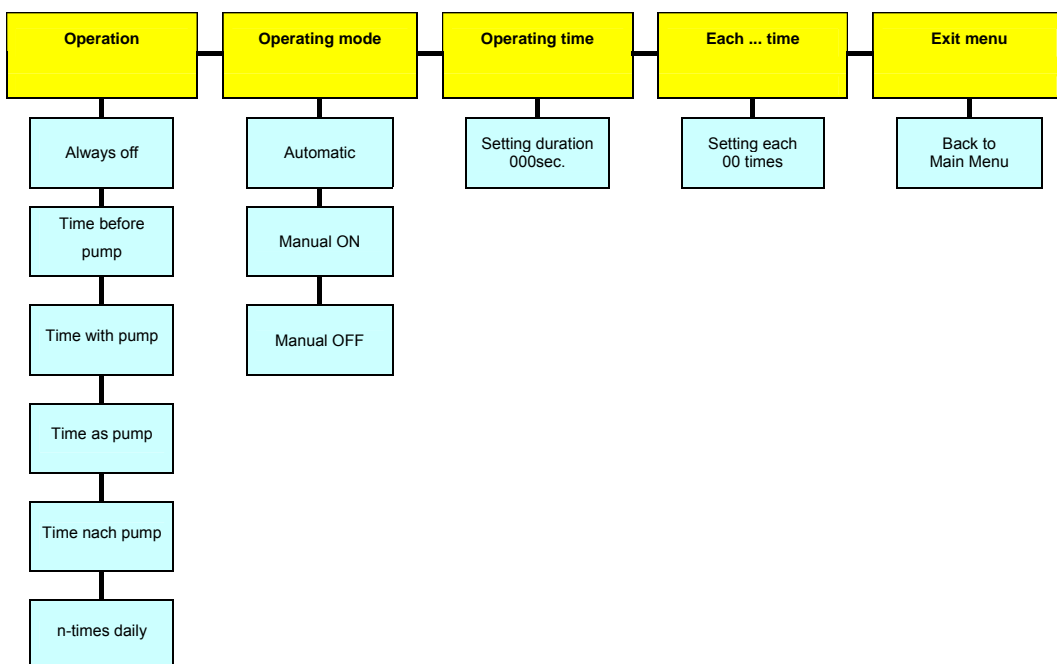

**Function:** This sub-menu allows you to determine how the compressor or agitator operates.

- **Always off:** The compressor or agitator is deactivated and will not be activated automatically. The control unit will operate like a standard control unit. Even manual activation of the agitator is not possible. Alarm relay 1 can therefore be used as an alarm relay.
- **Time before pump:** The agitator is activated once the activation level has been reached before the pumps start and will run for the time set. Once this time has elapsed the pump(s) start.
- **Time with pump:** The agitator starts with the pump(s) and runs for the set running time.
- **Time as pump:** The agitator starts with the pump(s) and runs for the same length of time as the pump(s).
- **N-times per day:** The compressor or agitator starts n-times per day and runs for the set running time.

<sup>33</sup> Only shown if compressor or agitator has been selected in the factory settings.



# Operating manual

## Basis pump control CPSB



**Running time:** This menu item sets allows you to set the running time of the compressor or agitator up to a maximum of “000-999 sec.”.

**every ... time:** This sub-menu allows you to set how often the compressor or agitator should start in the form of the “00 time”. If, for example, 03 time is chosen, two pump cycles are run without the compressor or agitator; the compressor or agitator only starts up on the third pump cycle. If a value of “00 time” or “01 time” is chosen in this menu, the compressor or agitator operates during every pumping cycle.

**Important:** After the settings have been changed or after a complete loss of the power supply, the first pumping cycle is not counted in order to restore the counting rhythm.

**A 00:00 time:** In this sub-menu the switching on time of the compressor or agitator is entered. At this time relay 1 would switch over for as long as determined by the entered running time.

**CAUTION:** If the compressor or agitator cannot run at the same time as the pump(s), this must be configured in the hardware. This cannot be prevented by software.

**IMPORTANT:** If the control unit is operated without a 12V battery and there is a loss of power, then the integrated clock also stops for the period the power is lost. This means that once the power returns the clock runs late and the switching on time for the compressor / agitator has shifted.

**Exit menu: (#197):** Back to the Main Menu.

## 12 Start-up / re-start

Please also refer to the operating manual for the pumps.

- Install the control unit in a dry, frost-free area that is protected from flooding
- Make the connections according to the relevant circuit diagram.
- Ensure pre-fusing of the equipment on-site corresponds to the guidelines in the relevant accompanying circuit diagram.
- The power supply corresponds to the information in the relevant circuit diagram. The connection to the control unit transformer may have to be adapted to the local conditions (input voltage  $\pm 5\%$ )
- The motor circuit breaker(s) setting must be compared to the nominal value of the pump(s) (pump identification plate) and corrected if necessary.
- Before switching on the power supply it is necessary to ensure that the equipment cannot be used for purposes other than those for which it was intended. The relevant motor circuit breakers of the control unit are switched off. The pumps are set via the operating mode (relevant P1 or P2 operating mode switch and/or sub-menu (#033 or #034)) to "0".



**Only at this point, is the power supply switched on**

- Set the parameters as required.
- Check the direction of rotation of the connected pump. Switch on the motor circuit breaker(s). The pumps are set via the operating mode (relevant P1 or P2 operating mode switch and/or sub-menu (#033 or #034) to "**manual operation**" for a short time. Please note that the connected pump is not damaged by an inadvertent dry run.
- The pumps are set via the operating mode (relevant switch P1 or P2 operating mode switch and/or sub-menu (#033 or #034) to "**automatic operation**".
- Then carry out a functional test.

## 13. Removal from service

After taking the equipment out of service, you must ensure that switching it off cannot lead to any consequential damages (such as unintended overflow, etc.). When working on the control unit and/or the components of the control unit, amongst others, the 5 safety rules of electrical engineering must be observed.

1. **Disconnection (switching off the mains power)**
2. **Secure against re-activation.**
3. **Ensure that the voltage is zero (suitable measuring device).**
4. **Earth and short-circuit.**
5. **Cover adjacent, live parts (potential-free contacts may carry voltage from a separate source).**

When working on the pump(s) and/or on the measuring system or on the installation as a whole, unintended activation of the pump(s) must be prevented.



**Please note that while working on the control unit, the pump(s) and/or the measuring system or the installation as a whole, people must never be placed at risk.**

### 14. Maintenance















We recommend that the control unit and all accessories (or even all the equipment) are checked at regular intervals depending on where they are used and what environmental influences they are subjected to.















- Visual inspection of the equipment and removal of any sedimentation.
- Visual inspection of the equipment and replacement of damaged components.
- Functional testing should be carried out.
- Inspection of measuring systems.
- The accumulator must be replaced at least every 5 years.

### 15. Technical data

Operating voltage	3 x 230V/400V 50 Hz +/- 10%
Power control (without power supply)	max. 29VA; Typ. 10VA
Control fuse	Microfuse 5 x 20 mm 3,15AT (EN 60127-2/III)
Input level sensor	4 ..20 mA (2-wire)
supply voltage level sensor	Typ. 24V=
Measuring accuracy input level sensor	± 1% v.E. ± 1cm WS
Measuring range input level sensor	adjustable between 0... 100cm WS and 0...1000cm
Measuring accuracy impact pressure	Typ. ±1,5% v.E. ± 2cm
Measuring range impact pressure	0 ... 200 cm WS
Display resolution level control	1cm
Short circuit current float switch input 1, HW	< 1mA
Switching voltage float switch input 1, HW	13,6 V=
Short circuit current float switch input 2,3	< 25mA
Switching voltage float switch input 2 ,3	24 V=
Short circuit current input thermal contact	< 10mA
Switching voltage input thermal contact	230VAC
Max. switching voltage isolated alarm relay	max. 230V AC / 24V DC
Switching current isolated alarm relay	5 A max.(AC1)
Measuring accuracy hourmeter	< 0,06% from the current value
Real time clock accuracy	±20ppm - 0,04ppm/°C
Required external fuse isolated alarm relay	max. 5A G
Operating temperature range	0 ... 50°C
Permissible storage temperature	-20 ... 70°C
Air humidity	0 ... 90% RH (non condensing)
Input phase failure / phase sequence monitoring	3 x 230/400V +/-10% 50Hz
Threshold for phase failure detection:	< 40V bei 50Hz
Battery:	Lead-Gel batteries, 12V, 1,2Ah
Battery charge current	max: 100 mA
Battery charge voltage	13,8V
Degree of protection	IP54 (with the lid closed)

### 16. Symbol definition

Symbols: Operating manual and control	
	Warning - general hazards
	Warning - electrical voltage
	Control mode "Manual mode"
	Control mode "OFF"
	Control mode "Automatic mode"
<b>P1</b>	Pump 1
<b>P2</b>	Pump 2
	Display mode / common fault Flashing green = operation Red on = Group fault
	Modes show the pump Green on = pump running Red on = pump fault Flashing red = pump in manual or off
	Manual - 0-automatic Mode adjustment of the respective pump
	Key lock By touching the keypad for 3 sec. it will be activated or deactivated.
	Alarm off
	Faults / alarms set back
	Scroll through the menu or change values.
	Selection menu or confirm
	Back to Main Menu or Cancel entry

Symbols: two-line display	
<b>HW</b>	High water
	Wait, no entry possible
	Battery operation
	Key lock activated
Symbols: two-line display	
	Mains operation
	voice connection active
	Flashes, when the control is on
Symbole: graph. Display	
	Flashes, when the control is on
	Mains operation
	Float switch „not switched“
	Float switch „switched“
	Actual display with the selected activation and deactivation levels
	display field strength GSM modem
	establishing a connection
	voice connection active
	data connection active

### 17. Fault list

Bit	Errorcode	Error
00	HW	<b>High water</b> If the measured level is above the selected alarm level or if the High water float is activated, this error message is triggered after the alarm delay time has elapsed. The pump(s) are switched on immediately once the High water enters, if there is no fault in the pump(s).
01	SENSOR	<b>Fault in the measuring system</b> There is a fault in the level measuring system. (Short circuit or interruption in the wiring to the level sensor, inconsistent activation status of the float) The pumps are switched off. If in this situation the High water float happens to be activated, the pumps are switched on if there is no fault in the pump(s).
02	pmin	<b>Minimum pressure exceeded</b> If taking level measurements via the internal dynamic pressure sensor, an alarm will be set off if the pressure falls below the minimum pressure.
03	--	Not used
04	Accu	<b>Accumulator voltage too low</b> The accumulator voltage of the control unit is under 10.5V, the accumulator has not been charged properly or has nearly run out if it is in operation
05	Power	<b>No mains</b> There is no control voltage to the control unit; the control unit will operate if an accumulator is present.
06	--	Not used
07	Modem	<b>Communication error</b> There is an error in the data communication system
08	--	Not used
09	--	Not used
10	P1TH	<b>Thermal contact has triggered</b> The thermal contacts on the pump 1 has triggered. The pump is turned off. This error should be acknowledged at the control. This error is stored non-volatile memory even after power failure.
11	P1MS	<b>Manual motor starter has tripped</b> The manual motor starter of the pump 1 is triggered. The pump is turned off. Is in the auto alarm reset mask the position AUTOMATIC is selected, control passes to turn the motor breaker automatically again
12	--	Not used
13	--	Not used
14	P1tmax	<b>Running time out</b> The max. Pump run time is exceeded
15	P1Imin	<b>Pump current is too low</b> The electronic motor protection measures a motor current at the pump 1, which is less than half the rated current.
16	P1Imax	<b>Pump current is too high</b> The electronic motor protection of the pump 2 is caused by excess current. The pump is turned off. Is in the auto alarm reset mask the position AUTOMATIC is selected, the control goes to the waiting time automatically again.

# Operating manual

## Basis pump control CPSB



Bit	Errorcode	Error
17	I2C-GLP	Communication with base circuit board defective
18	--	Not used
19	extern	external Alarm The entrance SW2 (not float operation) is closed
		<b>Note: Error bits 20 - 31 only for 2-pump control</b>
20	--	Not used
21	--	Not used
22	P2TH	Thermal contact 2 pump 2 has triggered The second thermal contacts on the pump 2 is triggered. The pump is turned off. This error should be acknowledged at the control. This error is stored non-volatile memory even after power failure .
23	P2MS	Manual motor starter has tripped pump 2 The manual motor starter of the pump 2 is triggered. The pump is turned off. Is in the auto alarm reset mask the position AUTOMATIC is selected, control passes to turn the motor breaker automatically again
24	--	Not used
25	--	Not used
26	P2tmax	Running time out pump 2 The max. Pump run time is exceeded
27	P2Imin	Pump current is too low pump 2 The electronic motor protection measures a motor current at the pump 1, which is less than half the rated current.
28	P2Imax	Pump current is too high The electronic motor protection of the pump 2 is caused by excess current. The pump is turned off. Is in the auto alarm reset mask the position AUTOMATIC is selected, the control goes to the waiting time automatically again.
29	--	Not used
30	--	Not used
31	SD-Modul	Disturbance of the dynamic pressure measurement module The optional dynamic pressure measurement module has a defect, or possibly is not plugged in correctly.

# Operating manual

## Basis pump control CPSB



### 18. Error code table (mask codes) for control units with two-line displays

Bit	Error short text	Group	BIN in group	Error
<b>General Error</b>				
0	HW	Group 1	0001	High water
1	SENSOR		0010	Minimum pressure drops below
2	pmin		0100	Minimum pressure drops below
3	-		1000	(not used)
4	Accu	Group 2	0001	Battery voltage too low
5	Power		0010	No mains voltage
6	-		0100	(not used)
7	Modem		1000	Communication errors
<b>Error pump 1</b>				
8	-	Group 3	0001	(not used)
9	-		0010	(not used)
10	P1TH		0100	Thermal contact 2 has triggered
11	P1MS		1000	Manual motor starter has tripped
12	-	Group 4	0001	(not used)
13	-		0010	(not used)
14	P1tmax		0100	Running time out
15	P1lmin		1000	Pump current is too low
16	P1lmax	Group 5	0001	Pump current is too high
17	-		0010	(not used)
18	-		0100	(not used)
<b>External fault trip (only in the two-pump operation)</b>				
19	extern	Gruppe 5	1000	Input float switch 2 has switched
<b>Error pump 2 (only in the two-pump operation)</b>				
20	-	Group 6	0001	(not used)
21	-		0010	(not used)
22	P2TH		0100	Thermal contact 2 has triggered
23	P2MS		1000	Manual motor starter has tripped
24	-	Group 7	0001	(not used)
25	-		0010	(not used)
26	P2tmax		0100	Running time out
27	P2lmin		1000	Pump current is too low
28	P2lmax	Group 8	0001	Pump current is too high
29	-		0010	(not used)
30	-		0100	(not used)
31	-		1000	-

Table of error bits

BIN	HEX	BIN	HÉX
0000	0	1000	8
0001	1	1001	9
0010	2	1010	A
0011	3	1011	B
0100	4	1100	C
0101	5	1101	D
0110	6	1110	E
0111	7	1111	F

Conversion of the group bits into a hexadecimal number

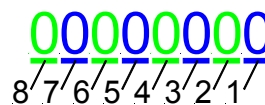

Group position of the hexadecimal bits

#### **Explanation:**

In each case, 4 bits are combined into one group. There are a total of 8 groups. Four error bits are coded in each group (0000, 0001, ...). These are summarised and converted to a hexadecimal number (0, 1, 2, ..., E, F) via the conversion table. This hexadecimal number is entered in the group position of the chosen mask. If the bit is not put into the mask, the error is detected and processed by the control unit, but it is not transmitted to the relevant relay.

#### **Example:**

In the first group, the errors HW (0001), sensor (0010) and 30 (1000) should be activated. This results in the bit 1011 for group 1. Using the conversion table, the group bit 1011 becomes the hexadecimal number B. This is entered in group position 1 of the relevant mask.



### 19. Factory settings

The following factory settings are provided on delivery of the standard control unit. If the control unit is ordered with additional equipment, any necessary adjustments of the settings will have been carried out

For example, if a pressure measurement module is ordered, the level measuring system is reset to dynamic pressure. Or if a horn is ordered, which is accessed via an alarm relay, the relay is declared as "Can be confirmed".

Depending on the configuration of the control unit, not all parameters presented here will be included. With the graphical display certain settings are set via a selection menu and via a hexadec. code, such as the two-line display.

Possible customer settings are not taken into account here.

Main Menu	Sub-menu	Standard setting 1-pump	Standard setting 2-pumps
<b>Level measurement:</b>	Level measurement	4-20mA: 400cm	4-20mA: 400cm
	Filter	0000	0000
	Off level P1	0010cm	0010cm
	Off level P2	-----	0020cm
	On level P1	0040cm	0040cm
	On level P2	-----	0060cm
	Alarm level	0090cm	0090cm
<b>Pump data:</b>	Follow-up time	0000sec	0000sec
	Last change after	-----	0000min
	Max. run time	0000min	0000min
	Delay P1>P2	-----	04 sec
	Nominal currentP1	00.0A	00.0A
	Nominal currentP1 P2	-----	00.0A
<b>Alarme:</b>	Alarm autoreset mask	1C61C600	1C61C600
	Alarm buzzer	On	On
	Alarm relay 1	NC	NC
	Alarm relay 2	NC	NC
	Alarm relay 3	NC	NC
	Mask relay 1	7FFFFFFF	7FFFFFFF
	Mask relay 2	7FF7FF00	7FF7FF00
	Mask relay 3	00000001	00000001
	Alarm relay 1 Quit.	No	No
	Alarm relay 2 Quit.	No	No
	Alarm relay 3 Quit.	No	No
	Alarm delay HW	0000s	0000s
<b>Default:</b>	Language	German	German
	Password	0000	0000
	Number of pumps	1 STD	2 STD
	Delay on make	0003sec	0003sec
	Short start-all	0048h for 03sec	0048h f. 03sec
	Emptying all	0024h	0024h
	Date: time:	Current	Current
		Input	Input





Main Menu	Sub-menu	Standard setting 1-pump	Standard setting 2-pumps
<b>Timer:</b>	Operating hours P1	- display only -	- display only -
	Operating hours P2	-----	- display only -
	Cycles P1	- display only -	- display only -
	Cycles P2	-----	- display only -
	Service due P1	999999 h	999999 h
	Service due P2	-----	999999 h
	Service due Date	31.12.99	31.12.99
	Service Tel. Nr.		
<b>Agitator / compressor:</b>	Fct. Agitator/compres. Mode	always Off automatically	always Off automatically
	___run-time	000sec	000sec
	___each	03 times	03 times

## 20. Examples of alarm settings

The following hexadec codes are most commonly used to set the parameters of the three alarm relays.

Hex.Dez. Code	Function
7FFFFFFF	Alarm (any disturbances lead to the release)
0007FF00	Interference of the pump 1
7FF00000	Interference of the pump 2
7FF7FF00	Interference of the pump 1 and pump 2
00000001	High water alarm
00000002	Sensor error (error in the pressure measurement module or the 4-20mA input result to trigger)

# Operating manual

## Basis pump control CPSB



### 21. SMSC-No. - list

Warning: These are only examples.

For safety reasons the current SMSC No. must be obtained from the relevant provider.

Country	Operater	SMSC-number
Austria	max.mobil	+43676021
	Mobilkom A1	+436640501
		+433340501
	Connect One	+436990001999
	T mobil	+43676021
	tele.ring	+4365009000000
Belgium	Orange	+32486000005
	Proximus	+3275161612
		+3275161616
	Mobistar	+3295955205
Bosnia Herzogovina	PTT GSM	+38790225522
Cyprus	Cyprus	+3579700000
Croatia	Cronet	+385980501
	Vipnet	+385910401
Czech rep	Radiomobil	+420603051
	Eurotel	+420602909909
Denmark	Telia DK	+4528187000
	Mobilix	+4526265151
	TeleDanmark	+4540390999
	Sonofon	+4540590000
Estonia	Ritabell	+3725509911
	Radiolinja	+372568771010
	EMT	+3725099000
Finland	Radiolinja	+358508771010
	Sonera	+358405202000
France	SFR	+33609001390
	Itineris	+3368900458
		+33689004431
		+33689004000
	Bouygues	+33660003000
Germany	E-Plus	+491770600000
		+491770610000
		+491770620000
	T-Mobile D1	+491710760000
		+491715990000
	Vodafone D2	+491722270000
		+491722270042
		+491722270111
		+491722270010
		+491722270222
		+491722270333
	O2	+491760000443
		+491760000433
	Mobilcom D1	+491710760315
	Mobilcom D2	+4917202270880
	Mobilcom E-Plus	+491770610000
	D1 Talkline	+491710760900
	D2 Talkline	+491722270258
	Debitel	+491722270222
	IC3S	+491722270201
Dr Materna	+491722270111	
E2	+491760000443	
	+3093597000	
Panafon	+3094219000	

# Operating manual

## Basis pump control CPSB



Country	Operater	SMSC-number
Greece	Cosmote	+3097100000
	Telestet	+3093599000
		+3093597000
	Panafon	+3094219000
Hungary	Pannon	+36209300099
		+36309610000
	Westel900	+36309888000
	Vodafone	+36309303100
Ireland	Eircell	+36709996500
		+35387699989
	Esat	+35387699985
Italy	Omnitel	+353868002000
		+393492000200
		+393492000300
		+393492000400
	TIM	+393492000500
		+393359609600
		+39338980000
		+393359608000
	Wind	+39338960960
	Island	Landssimi
Tal		+3548900100
Isle of man	Pronto GSM	+3546999099
Latvia	LMT	+447624499955
	Baltcom	+3719202020
Lithuania	Omnitel	+3719599994
	Bite GSM	+3709899992
Luxembourg	PTT	+3709950115
	Tango	+352021100003
Netherlands		+352091000030
	Telfort	+31626000230
	PTT	+31653131313
Norway	Libertel	+316540881000
	NetCom	+479208977
		+4792001000
	TeleNor	+4790002100
Poland		+4790007777
	Era GSM	+48602951111
		+48602951112
	Polkomtel	+48601000310
		+48601000311
IDEA Centertel	+48501200777	
Portugal	Telcel	+351911616161
	TMN	+351936210000
	Optimus	+35193121314
Romania	Connex	+4092004000
	Dialog	+4094946000
Russia	North West	+78129600096
	MTS	+70957699100
Serbia	MobTel	+38163100100
		+38163100300
	PTT Telekom	+381650000900
		+381640000900
Slovakia	Eurotel	+421903333000
	Globtel	+421905303303
Slovenia	Mobitel	+38641001333
	Si.Mobil	+38640441000
	Amena	+34656000311
	Airtel	+34607133000
		+34607003110

# Operating manual

## Basis pump control CPSB



Country	Operater	SMSC-number
Spain	Telefonica	+34609090909
	Amena	+34656000311
	Airtel	+34607133000
		+34607003110
Sweden	Comviq	+46707773078
		+46707990001
		+46707990002
		+46707990003
	Telia	+46705008999
Switzerland	Europolitan	+46708000708
	diAX	+41765980000
	Swisscom	+41794999000
		+4179191
Orange	+41787777070	
Turkey	Telsim	+905429800033
	Turkcell	+905329010000
		+905329020000
		+905329030000
		+905329040000
United Kingdom	Vodafone	+44385016005
	One2One	+447958879879
	Virgin Mobile	+447958879890
	Orange	+44973100973
		+44973100974
	CellNet	+44802000332
	Isle of Man Pronto	+447624499955
Jersey	+447797704444	
Ukraine	UMC	+38050000501
	Kyivstar	+380672020000
	Golden Telecom	+380444990000
	Wellcome	+380442517777
Yugoslavia	Mob Tel	+38163100100
		+38163100200
		+38163100300
		+38163100400
	PTT Telekom Serbia	+381650000900

# Operating manual

## Basis pump control CPSB



## 22. Declaration of Conformity



Condor Pressure Control GmbH · Warendorfer Str. 47-51 · D-59320 Ennigerloh

### Konformitätserklärung Declaration of Conformity Déclaration de Conformité



Diese Konformitätserklärung entspricht der Europäischen Norm EN 45014 "Allgemeine Kriterien für Konformitätserklärungen von Anbietern".  
This Declaration of Conformity complies with the European Standard EN 45014 "General criteria for the supplier's declaration of conformity".  
Cette déclaration de conformité correspond à la Norme Européenne EN 45014 "critères généraux pour des déclarations de conformité des soumissionnaires".

Wir / We / Nous Condor Pressure Control GmbH, D-59320 Ennigerloh (Germany)

erklären in alleiniger Verantwortung, dass das Produkt  
declare under our sole responsibility that the product  
déclarons sous notre seule responsabilité que le produit

**Pumpensteuerung**  
**Pump Control Unit**  
**Équipement des pompes**

**CPS-m, CPS-B1 und CPS-B2 mit 2 x 16 LCD**  
**CPS-m, CPS-B1 und CPS-B2 mit graphischem LCD**

auf das sich diese Erklärung bezieht, mit den folgenden Normen übereinstimmt.  
to which this declaration relates is in conformity with the following standards.  
auquel se réfère cette déclaration est conforme aux normes.

EN 60204-1 (2007)  
EN 61000-6-3 (2007)  
EN 61000-6-1 (2007)  
EN 61000-3-2 (2006)

Gemäß den Bestimmungen der Richtlinie(n)  
Following the provisions of Directive(s)  
Conformément aux dispositions de Directive(s)

2006/95/EG (Niederspannungsrichtlinie, Low-voltage guideline, Directive de basse tension)  
2004/108/EG (EMV – Richtlinie, Guideline, Directive)

Westkirchen, den 30.11.2009

**Condor Pressure Control GmbH**  
Warendorfer Straße 47-51  
59320 Ennigerloh  
Dipl. Ing. Stefan Köster

Name und Unterschrift des Befugten  
Name and signature of authorized person  
Nom et signature de l'autorisé

Condor Pressure Control GmbH  
Warendorfer Str. 47-51  
D-59320 Ennigerloh/Germany  
Phone +49 (0)25 87-89-0  
Fax +49 (0)25 87-89-140  
info@condor-cpc.com  
www.condor-cpc.com

Condor Pressure Control GmbH, Ennigerloh  
Registergericht Münster HRB 10065  
Geschäftsführer Dipl.-Kfm. Marcus Frede  
USt-IdNr. DE 814475375  
Steuer-Nr. 366/5880/3464  
Gesellschafter Condor-Werke Gebr. Frede GmbH, Ennigerloh  
Registergericht Münster HRB 9734

Bankverbindungen  
Sparkasse Münsterland Ost BLZ 400 501 50 Kto 34 067 587  
SWIFT-BIC WELADED1MST  
IBAN DE 0240050150034067587  
Commerzbank AG BLZ 412 800 43 Kto 0 554 257 100  
SWIFT-BIC DRESDEFF413  
IBAN DE 74412800430554257100



**Condor Pressure Control GmbH**

**Warendorfer Straße 47 - 51  
D-59320 Ennigerloh**

**Phone: +49 (0) 25 87 / 89 - 0  
Telefax: +49 (0) 25 87 / 89 - 140**

**[info@condor-cpc.com](mailto:info@condor-cpc.com)  
[www.condor-cpc.com](http://www.condor-cpc.com)**